

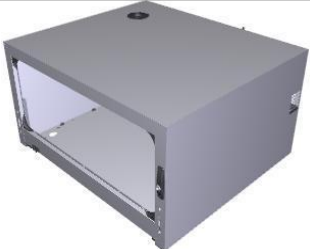



| Assembly code | Assembly description | Assembly image |
|----------------|----------------------|---|
| ASM3403A/0.D01 | Cooking chamber |  |
| ASM3409A/0.D02 | External cover |  |
| ASM3421B/0.D00 | Door |  |
| ASM8226A/0.D00 | Electrical system |  |



ASM3403A/0.D01 - Cooking chamber - FRONT

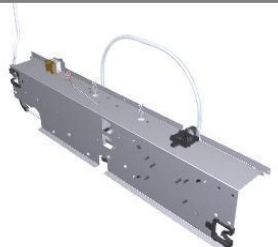
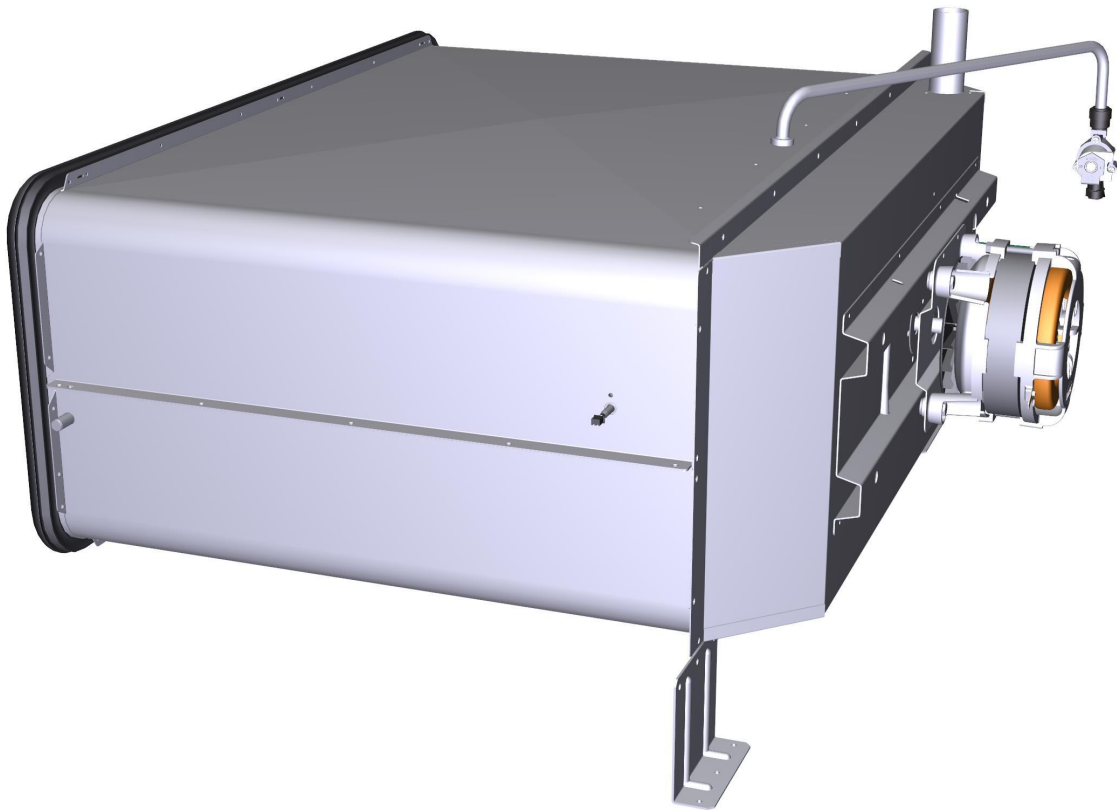





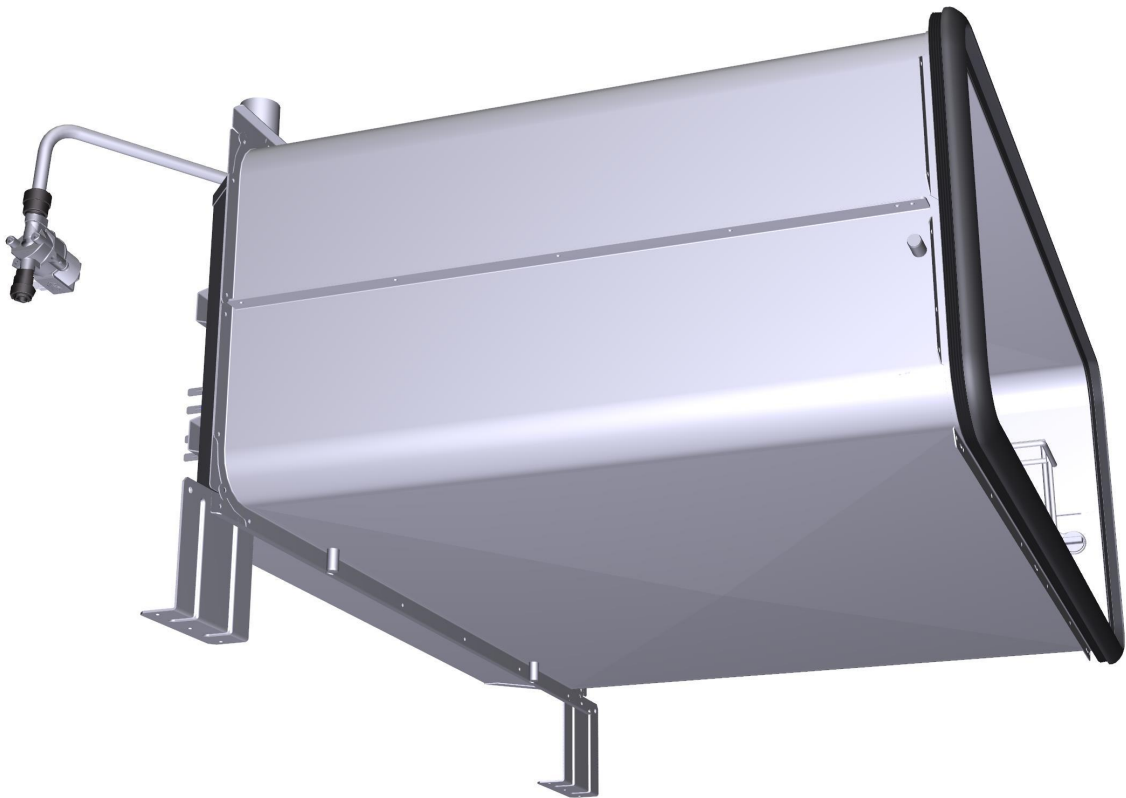



ASM3403A/0.D01 - Cooking chamber - REAR

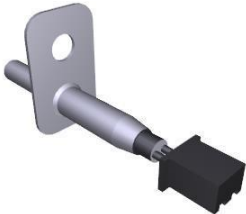







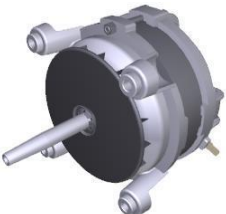

| COMPONENT | | | SPARE PART | | | | | | | | | | | | | | | | | | | | | | | | | | | | | | | | | | | | | | | | | | |
|-----------|-------------------------------------|---|------------|-----------------------------------|--|------|-------------|-----|-----|----------|-----------------------|-------|----|----------|-----------------------------|-------|----|----------|--------------------------------|-------|----|----------|-------------------------------------|-------|----|----------|--------------------------------|-------|----|----------|--------------------------------|-------|----|----------|--------------------------------|-------|----|----------|--------------------------------|-------|----|----------|--------------------|-------|----|
| Code | Description | Image | Code | Description | Kit components | | | | | | | | | | | | | | | | | | | | | | | | | | | | | | | | | | | | | | | | |
| 0G1653A | ELENA SHOP PRO FAN GUARD |  | 0G1653A1 | ELENA SHOP PRO FAN GUARD | | | | | | | | | | | | | | | | | | | | | | | | | | | | | | | | | | | | | | | | | |
| 0H7875A | SHOP.PRO MUFFLE SUPPORT BRACKET |  | 0H7875A1 | SHOP.PRO MUFFLE SUPPORT BRACKET | | | | | | | | | | | | | | | | | | | | | | | | | | | | | | | | | | | | | | | | | |
| TR1105A | L1000 PT100 TEMPERATURE PROBE |  | KTR1105A | PT100 L1000 TEMPERATURE PROBE KIT | <table border="1"> <thead> <tr> <th>Code</th> <th>Description</th> <th>Qty</th> <th>UOM</th> </tr> </thead> <tbody> <tr> <td>0H4302A0</td> <td>PROBES SILICON HOLDER</td> <td>1.000</td> <td>PC</td> </tr> <tr> <td>GN1120A1</td> <td>NTC TEMPERATUR E PROBE SEAL</td> <td>1.000</td> <td>PC</td> </tr> <tr> <td>GN1285A0</td> <td>NTC TEMPERATUR E PROBE SEALING</td> <td>1.000</td> <td>PC</td> </tr> <tr> <td>SL1045A0</td> <td>S57 BLACK SILICONE - 80ml CARTRIDGE</td> <td>1.000</td> <td>PC</td> </tr> <tr> <td>TR1105A4</td> <td>L1000 PT100 TEMPERATUR E PROBE</td> <td>1.000</td> <td>PC</td> </tr> <tr> <td>VI1220A1</td> <td>4,2x12 TCB SELF-TAPPIN G SCREW</td> <td>2.000</td> <td>PC</td> </tr> <tr> <td>VM1464A1</td> <td>CT BT TEMPERATUR E PROBE COVER</td> <td>1.000</td> <td>PC</td> </tr> <tr> <td>VM1465A1</td> <td>CT BT TEMPERATUR E PROBE COVER</td> <td>1.000</td> <td>PC</td> </tr> <tr> <td>VM2052A0</td> <td>LM CORE PROBE COVE</td> <td>1.000</td> <td>PC</td> </tr> </tbody> </table> | Code | Description | Qty | UOM | 0H4302A0 | PROBES SILICON HOLDER | 1.000 | PC | GN1120A1 | NTC TEMPERATUR E PROBE SEAL | 1.000 | PC | GN1285A0 | NTC TEMPERATUR E PROBE SEALING | 1.000 | PC | SL1045A0 | S57 BLACK SILICONE - 80ml CARTRIDGE | 1.000 | PC | TR1105A4 | L1000 PT100 TEMPERATUR E PROBE | 1.000 | PC | VI1220A1 | 4,2x12 TCB SELF-TAPPIN G SCREW | 2.000 | PC | VM1464A1 | CT BT TEMPERATUR E PROBE COVER | 1.000 | PC | VM1465A1 | CT BT TEMPERATUR E PROBE COVER | 1.000 | PC | VM2052A0 | LM CORE PROBE COVE | 1.000 | PC |
| Code | Description | Qty | UOM | | | | | | | | | | | | | | | | | | | | | | | | | | | | | | | | | | | | | | | | | | |
| 0H4302A0 | PROBES SILICON HOLDER | 1.000 | PC | | | | | | | | | | | | | | | | | | | | | | | | | | | | | | | | | | | | | | | | | | |
| GN1120A1 | NTC TEMPERATUR E PROBE SEAL | 1.000 | PC | | | | | | | | | | | | | | | | | | | | | | | | | | | | | | | | | | | | | | | | | | |
| GN1285A0 | NTC TEMPERATUR E PROBE SEALING | 1.000 | PC | | | | | | | | | | | | | | | | | | | | | | | | | | | | | | | | | | | | | | | | | | |
| SL1045A0 | S57 BLACK SILICONE - 80ml CARTRIDGE | 1.000 | PC | | | | | | | | | | | | | | | | | | | | | | | | | | | | | | | | | | | | | | | | | | |
| TR1105A4 | L1000 PT100 TEMPERATUR E PROBE | 1.000 | PC | | | | | | | | | | | | | | | | | | | | | | | | | | | | | | | | | | | | | | | | | | |
| VI1220A1 | 4,2x12 TCB SELF-TAPPIN G SCREW | 2.000 | PC | | | | | | | | | | | | | | | | | | | | | | | | | | | | | | | | | | | | | | | | | | |
| VM1464A1 | CT BT TEMPERATUR E PROBE COVER | 1.000 | PC | | | | | | | | | | | | | | | | | | | | | | | | | | | | | | | | | | | | | | | | | | |
| VM1465A1 | CT BT TEMPERATUR E PROBE COVER | 1.000 | PC | | | | | | | | | | | | | | | | | | | | | | | | | | | | | | | | | | | | | | | | | | |
| VM2052A0 | LM CORE PROBE COVE | 1.000 | PC | | | | | | | | | | | | | | | | | | | | | | | | | | | | | | | | | | | | | | | | | | |





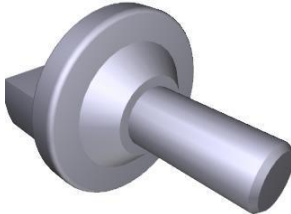

| COMPONENT | | | SPARE PART | | | | | | | | | | | | | | | | | | | | | | |
|-----------|--|---|------------|---------------------------------------|---|------|-------------|-----|-----|----------|----------------------------|-------|----|----------|----------------------------|-------|----|----------|---------------------------------|-------|----|----------|--|-------|----|
| Code | Description | Image | Code | Description | Kit components | | | | | | | | | | | | | | | | | | | | |
| EL1251A | 1-WAY WATER SOLENOID VALVE |  | KEL1251A | JG D8-D10 1 WAY SOLENOID VALVE KI | <table border="1"> <thead> <tr> <th>Code</th> <th>Description</th> <th>Qty</th> <th>UOM</th> </tr> </thead> <tbody> <tr> <td>EL1251A0</td> <td>1-WAY WATER SOLENOID VALVE</td> <td>1.000</td> <td>PC</td> </tr> </tbody> </table> | Code | Description | Qty | UOM | EL1251A0 | 1-WAY WATER SOLENOID VALVE | 1.000 | PC | | | | | | | | | | | | |
| Code | Description | Qty | UOM | | | | | | | | | | | | | | | | | | | | | | |
| EL1251A0 | 1-WAY WATER SOLENOID VALVE | 1.000 | PC | | | | | | | | | | | | | | | | | | | | | | |
| 0H3020A | MOTOR SHAFT SEALING DISC |  | 0H3020A1 | MOTOR SHAFT SEALING DISC | | | | | | | | | | | | | | | | | | | | | |
| 0H7170A | MM MOTOR GLASS WOOL PLATE |  | 0H7170A0 | MM MOTOR GLASS WOOL PLATE | | | | | | | | | | | | | | | | | | | | | |
| GN1547A | SHAFT GASKET D11.8 |  | KG1547A | D11.6 MOTOR SHAFT GASKET 3PCS KIT | <table border="1"> <thead> <tr> <th>Code</th> <th>Description</th> <th>Qty</th> <th>UOM</th> </tr> </thead> <tbody> <tr> <td>GN1547A1</td> <td>SHAFT GASKET D11.8</td> <td>3.000</td> <td>PC</td> </tr> </tbody> </table> | Code | Description | Qty | UOM | GN1547A1 | SHAFT GASKET D11.8 | 3.000 | PC | | | | | | | | | | | | |
| Code | Description | Qty | UOM | | | | | | | | | | | | | | | | | | | | | | |
| GN1547A1 | SHAFT GASKET D11.8 | 3.000 | PC | | | | | | | | | | | | | | | | | | | | | | |
| MT1012A | 330W 230V MOTOR |  | KVN1130A | LUX ≤08.2017/L.MISS/S.5/ 5E MOTOR KIT | <table border="1"> <thead> <tr> <th>Code</th> <th>Description</th> <th>Qty</th> <th>UOM</th> </tr> </thead> <tbody> <tr> <td>0H8118A0</td> <td>XEVL MOTOR SHAFT DISC</td> <td>1.000</td> <td>PC</td> </tr> <tr> <td>GN1140A3</td> <td>MOLDED MOTOR HOLDER GASKET</td> <td>1.000</td> <td>PC</td> </tr> <tr> <td>V11034A0</td> <td>STAINLESS STEEL WASHER 8.4x16x1</td> <td>1.000</td> <td>PC</td> </tr> <tr> <td>V11256A0</td> <td>M8 DIN 980M ST. STEEL SELF LOCKING NUT</td> <td>1.000</td> <td>PC</td> </tr> </tbody> </table> | Code | Description | Qty | UOM | 0H8118A0 | XEVL MOTOR SHAFT DISC | 1.000 | PC | GN1140A3 | MOLDED MOTOR HOLDER GASKET | 1.000 | PC | V11034A0 | STAINLESS STEEL WASHER 8.4x16x1 | 1.000 | PC | V11256A0 | M8 DIN 980M ST. STEEL SELF LOCKING NUT | 1.000 | PC |
| Code | Description | Qty | UOM | | | | | | | | | | | | | | | | | | | | | | |
| 0H8118A0 | XEVL MOTOR SHAFT DISC | 1.000 | PC | | | | | | | | | | | | | | | | | | | | | | |
| GN1140A3 | MOLDED MOTOR HOLDER GASKET | 1.000 | PC | | | | | | | | | | | | | | | | | | | | | | |
| V11034A0 | STAINLESS STEEL WASHER 8.4x16x1 | 1.000 | PC | | | | | | | | | | | | | | | | | | | | | | |
| V11256A0 | M8 DIN 980M ST. STEEL SELF LOCKING NUT | 1.000 | PC | | | | | | | | | | | | | | | | | | | | | | |

| COMPONENT | | | SPARE PART | | | | | | | | | | | | | | | | | | | | | | | | | | | | | | | |
|-----------|---|--|------------|---|--|------|-------------|---|-------|----------|-----------------------------------|-----------------------------------|-------|----------|--|-------------------------------------|-------|----------|-------------------------------------|--------------------|-------|----|----------|------------------------|-------|----|----------|--|-------|----|----------|----------------------------|-------|----|
| Code | Description | Image | Code | Description | Kit components | | | | | | | | | | | | | | | | | | | | | | | | | | | | | |
| MT1012A | 330W 230V MOTOR |  | KVN1130A | LUX ≤08.2017/L.MISS/S.5/ 5E MOTOR KIT | <table border="1"> <thead> <tr> <th>Code</th> <th>Description</th> <th>Qty</th> <th>UOM</th> </tr> </thead> <tbody> <tr> <td>VM2196A0</td> <td>MOTOR NUT FASTENING BUSHING</td> <td>1.000</td> <td>PC</td> </tr> <tr> <td>VN1130A1</td> <td>330W 230V 50/60HZ MOTO</td> <td>1.000</td> <td>PC</td> </tr> </tbody> </table> | Code | Description | Qty | UOM | VM2196A0 | MOTOR NUT FASTENING BUSHING | 1.000 | PC | VN1130A1 | 330W 230V 50/60HZ MOTO | 1.000 | PC | | | | | | | | | | | | | | | | | |
| | | | Code | Description | Qty | UOM | | | | | | | | | | | | | | | | | | | | | | | | | | | | |
| VM2196A0 | MOTOR NUT FASTENING BUSHING | 1.000 | PC | | | | | | | | | | | | | | | | | | | | | | | | | | | | | | | |
| VN1130A1 | 330W 230V 50/60HZ MOTO | 1.000 | PC | | | | | | | | | | | | | | | | | | | | | | | | | | | | | | | |
| KMT1012A | LUX >08.2017 / MIND.MAPS 330W MOTOR KIT | <table border="1"> <thead> <tr> <th>Code</th> <th>Description</th> <th>Qty</th> <th>UOM</th> </tr> </thead> <tbody> <tr> <td>0H2842A0</td> <td>MT1012 CENTERING JI</td> <td>1.000</td> <td>PC</td> </tr> <tr> <td>0H8118A0</td> <td>XEVL MOTOR SHAFT DISC</td> <td>1.000</td> <td>PC</td> </tr> <tr> <td>GN1140A3</td> <td>MOLDED MOTOR HOLDER GASKET</td> <td>1.000</td> <td>PC</td> </tr> <tr> <td>MT1012A0</td> <td>330W 230V MOTOR</td> <td>1.000</td> <td>PC</td> </tr> <tr> <td>VI1077A1</td> <td>SCREW M6x12 TE INOX</td> <td>1.000</td> <td>PC</td> </tr> <tr> <td>VI1521A0</td> <td>STAINLESS STEEL WASHER D=6 6592</td> <td>1.000</td> <td>PC</td> </tr> <tr> <td>VI1966A1</td> <td>M4x14 FLATHEAD SCREW</td> <td>1.000</td> <td>PC</td> </tr> </tbody> </table> | Code | Description | Qty | UOM | 0H2842A0 | MT1012 CENTERING JI | 1.000 | PC | 0H8118A0 | XEVL MOTOR SHAFT DISC | 1.000 | PC | GN1140A3 | MOLDED MOTOR HOLDER GASKET | 1.000 | PC | MT1012A0 | 330W 230V MOTOR | 1.000 | PC | VI1077A1 | SCREW M6x12 TE INOX | 1.000 | PC | VI1521A0 | STAINLESS STEEL WASHER D=6 6592 | 1.000 | PC | VI1966A1 | M4x14 FLATHEAD SCREW | 1.000 | PC |
| Code | Description | Qty | UOM | | | | | | | | | | | | | | | | | | | | | | | | | | | | | | | |
| 0H2842A0 | MT1012 CENTERING JI | 1.000 | PC | | | | | | | | | | | | | | | | | | | | | | | | | | | | | | | |
| 0H8118A0 | XEVL MOTOR SHAFT DISC | 1.000 | PC | | | | | | | | | | | | | | | | | | | | | | | | | | | | | | | |
| GN1140A3 | MOLDED MOTOR HOLDER GASKET | 1.000 | PC | | | | | | | | | | | | | | | | | | | | | | | | | | | | | | | |
| MT1012A0 | 330W 230V MOTOR | 1.000 | PC | | | | | | | | | | | | | | | | | | | | | | | | | | | | | | | |
| VI1077A1 | SCREW M6x12 TE INOX | 1.000 | PC | | | | | | | | | | | | | | | | | | | | | | | | | | | | | | | |
| VI1521A0 | STAINLESS STEEL WASHER D=6 6592 | 1.000 | PC | | | | | | | | | | | | | | | | | | | | | | | | | | | | | | | |
| VI1966A1 | M4x14 FLATHEAD SCREW | 1.000 | PC | | | | | | | | | | | | | | | | | | | | | | | | | | | | | | | |
| VN1181A | M6 NUT 39 BLADES H81 D196 FAN |  | KVN1181A | D196 H81 39 BLADES FAN+SCREW M6 KIT | <table border="1"> <thead> <tr> <th>Code</th> <th>Description</th> <th>Qty</th> <th>UOM</th> </tr> </thead> <tbody> <tr> <td>VI1077A1</td> <td>SCREW M6x12 TE INOX</td> <td>1.000</td> <td>PC</td> </tr> <tr> <td>VI1521A0</td> <td>STAINLESS STEEL WASHER D=6 6592</td> <td>1.000</td> <td>PC</td> </tr> <tr> <td>VN1181A0</td> <td>M6 NUT 39 BLADES H81 D196 FAN</td> <td>1.000</td> <td>PC</td> </tr> </tbody> </table> | Code | Description | Qty | UOM | VI1077A1 | SCREW M6x12 TE INOX | 1.000 | PC | VI1521A0 | STAINLESS STEEL WASHER D=6 6592 | 1.000 | PC | VN1181A0 | M6 NUT 39 BLADES H81 D196 FAN | 1.000 | PC | | | | | | | | | | | | | |
| | | | Code | Description | Qty | UOM | | | | | | | | | | | | | | | | | | | | | | | | | | | | |
| VI1077A1 | SCREW M6x12 TE INOX | 1.000 | PC | | | | | | | | | | | | | | | | | | | | | | | | | | | | | | | |
| VI1521A0 | STAINLESS STEEL WASHER D=6 6592 | 1.000 | PC | | | | | | | | | | | | | | | | | | | | | | | | | | | | | | | |
| VN1181A0 | M6 NUT 39 BLADES H81 D196 FAN | 1.000 | PC | | | | | | | | | | | | | | | | | | | | | | | | | | | | | | | |
| KVN1030A | LUX ≤08.2017S.5/S.5E D196 FAN KIT | <table border="1"> <thead> <tr> <th>Code</th> <th>Description</th> <th>Qty</th> <th>UOM</th> </tr> </thead> <tbody> <tr> <td>VI1256A0</td> <td>M8 DIN 980M ST. STEEL SELF LOCKING NUT</td> <td>1.000</td> <td>PC</td> </tr> <tr> <td>VM2196A0</td> <td>MOTOR NUT FASTENING BUSHING</td> <td>1.000</td> <td>PC</td> </tr> <tr> <td>VN1030A5</td> <td>Ø196 H81 38 BLADES MOTOR FAN</td> <td>1.000</td> <td>PC</td> </tr> </tbody> </table> | Code | Description | Qty | UOM | VI1256A0 | M8 DIN 980M ST. STEEL SELF LOCKING NUT | 1.000 | PC | VM2196A0 | MOTOR NUT FASTENING BUSHING | 1.000 | PC | VN1030A5 | Ø196 H81 38 BLADES MOTOR FAN | 1.000 | PC | | | | | | | | | | | | | | | | |
| Code | Description | Qty | UOM | | | | | | | | | | | | | | | | | | | | | | | | | | | | | | | |
| VI1256A0 | M8 DIN 980M ST. STEEL SELF LOCKING NUT | 1.000 | PC | | | | | | | | | | | | | | | | | | | | | | | | | | | | | | | |
| VM2196A0 | MOTOR NUT FASTENING BUSHING | 1.000 | PC | | | | | | | | | | | | | | | | | | | | | | | | | | | | | | | |
| VN1030A5 | Ø196 H81 38 BLADES MOTOR FAN | 1.000 | PC | | | | | | | | | | | | | | | | | | | | | | | | | | | | | | | |

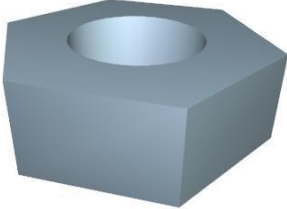
| COMPONENT | | | SPARE PART | | | | | | | | | | | | | | | | | | | | | | |
|-----------|---|---|------------|--|--|---|-------------|-----|-----|-----------|---------------------------------|--------|----|----------|---|-------|----|----------|-------------------------------------|-------|----|----------|-------------------------------|-------|----|
| Code | Description | Image | Code | Description | Kit components | | | | | | | | | | | | | | | | | | | | |
| RS1284A | 3200W 230V+400W 190V 4TURNS H80 ELEMENT |  | KRS1284A | 4TURN 3200W 230V+400W 190V HEAT ELEM KIT | <table border="1"> <thead> <tr> <th>Code</th> <th>Description</th> <th>Qty</th> <th>UOM</th> </tr> </thead> <tbody> <tr> <td>GN1327A0</td> <td>HEATING ELEMENT GASKET</td> <td>1.000</td> <td>PC</td> </tr> <tr> <td>RS1284A0</td> <td>3200W 230V+400W 190V 4TURNS H80 ELEMENT</td> <td>1.000</td> <td>PC</td> </tr> <tr> <td>SL1045A0</td> <td>S57 BLACK SILICONE - 80ml CARTRIDGE</td> <td>1.000</td> <td>PC</td> </tr> <tr> <td>VI1220A1</td> <td>4,2x12 TCB SELF-TAPPING SCREW</td> <td>2.000</td> <td>PC</td> </tr> </tbody> </table> | Code | Description | Qty | UOM | GN1327A0 | HEATING ELEMENT GASKET | 1.000 | PC | RS1284A0 | 3200W 230V+400W 190V 4TURNS H80 ELEMENT | 1.000 | PC | SL1045A0 | S57 BLACK SILICONE - 80ml CARTRIDGE | 1.000 | PC | VI1220A1 | 4,2x12 TCB SELF-TAPPING SCREW | 2.000 | PC |
| | | | | | Code | Description | Qty | UOM | | | | | | | | | | | | | | | | | |
| | | | | | GN1327A0 | HEATING ELEMENT GASKET | 1.000 | PC | | | | | | | | | | | | | | | | | |
| | | | | | RS1284A0 | 3200W 230V+400W 190V 4TURNS H80 ELEMENT | 1.000 | PC | | | | | | | | | | | | | | | | | |
| SL1045A0 | S57 BLACK SILICONE - 80ml CARTRIDGE | 1.000 | PC | | | | | | | | | | | | | | | | | | | | | | |
| VI1220A1 | 4,2x12 TCB SELF-TAPPING SCREW | 2.000 | PC | | | | | | | | | | | | | | | | | | | | | | |
| | | | | | | | | | | | | | | | | | | | | | | | | | |
| | | | | | | | | | | | | | | | | | | | | | | | | | |
| | | | | | | | | | | | | | | | | | | | | | | | | | |
| GRL1015A | L/R CHROMIUM PLATED LAT.SUPPORT |  | KGRL1015A | R/L 3 600x400 LM ELENA LATERAL SUPP KIT | <table border="1"> <thead> <tr> <th>Code</th> <th>Description</th> <th>Qty</th> <th>UOM</th> </tr> </thead> <tbody> <tr> <td>GRL1015A0</td> <td>L/R CHROMIUM PLATED LAT.SUPPORT</td> <td>2.000</td> <td>PC</td> </tr> </tbody> </table> | Code | Description | Qty | UOM | GRL1015A0 | L/R CHROMIUM PLATED LAT.SUPPORT | 2.000 | PC | | | | | | | | | | | | |
| | | | | | Code | Description | Qty | UOM | | | | | | | | | | | | | | | | | |
| GRL1015A0 | L/R CHROMIUM PLATED LAT.SUPPORT | 2.000 | PC | | | | | | | | | | | | | | | | | | | | | | |
| | | | | | | | | | | | | | | | | | | | | | | | | | |
| VM1815A | LATERAL SUPPORTS FIXING BOLT |  | KVM1815A | MISS/MICRO/S4/S3 THUMB SCREW 10 PCS KIT | <table border="1"> <thead> <tr> <th>Code</th> <th>Description</th> <th>Qty</th> <th>UOM</th> </tr> </thead> <tbody> <tr> <td>VM1815A0</td> <td>LATERAL SUPPORTS FIXING BOLT</td> <td>10.000</td> <td>PC</td> </tr> </tbody> </table> | Code | Description | Qty | UOM | VM1815A0 | LATERAL SUPPORTS FIXING BOLT | 10.000 | PC | | | | | | | | | | | | |
| | | | | | Code | Description | Qty | UOM | | | | | | | | | | | | | | | | | |
| VM1815A0 | LATERAL SUPPORTS FIXING BOLT | 10.000 | PC | | | | | | | | | | | | | | | | | | | | | | |
| | | | | | | | | | | | | | | | | | | | | | | | | | |
| GN1597A | GN1110A - SHOP.PRO ELENA DOOR GASKET |  | KGN1597A | BL SHOP.PRO ELENA DOOR GASKET KIT | <table border="1"> <thead> <tr> <th>Code</th> <th>Description</th> <th>Qty</th> <th>UOM</th> </tr> </thead> <tbody> <tr> <td>GN1597A1</td> <td></td> <td>1.000</td> <td>PC</td> </tr> <tr> <td>VM2277A0</td> <td>DOOR SEAL KIT INTERNAL CONNECTION</td> <td>1.000</td> <td>PC</td> </tr> </tbody> </table> | Code | Description | Qty | UOM | GN1597A1 | | 1.000 | PC | VM2277A0 | DOOR SEAL KIT INTERNAL CONNECTION | 1.000 | PC | | | | | | | | |
| | | | | | Code | Description | Qty | UOM | | | | | | | | | | | | | | | | | |
| GN1597A1 | | 1.000 | PC | | | | | | | | | | | | | | | | | | | | | | |
| VM2277A0 | DOOR SEAL KIT INTERNAL CONNECTION | 1.000 | PC | | | | | | | | | | | | | | | | | | | | | | |
| | | | | | | | | | | | | | | | | | | | | | | | | | |



| COMPONENT | | | SPARE PART | | | | | | | | | | |
|-----------|---|---|------------|---|---|------|-------------|-----|-----|----------|--|--------|----|
| Code | Description | Image | Code | Description | Kit components | | | | | | | | |
| RC1170A | M14 H=7 CH=22 STAINLESS STEEL NUT |  | KRC1170A | M14 H8 CH22 NUT - 10 PCS. KIT | <table border="1"> <thead> <tr> <th>Code</th> <th>Description</th> <th>Qty</th> <th>UOM</th> </tr> </thead> <tbody> <tr> <td>RC1170A1</td> <td>M14 H=7 CH=22 STAINLESS STEEL NUT</td> <td>10.000</td> <td>PC</td> </tr> </tbody> </table> | Code | Description | Qty | UOM | RC1170A1 | M14 H=7 CH=22 STAINLESS STEEL NUT | 10.000 | PC |
| Code | Description | Qty | UOM | | | | | | | | | | |
| RC1170A1 | M14 H=7 CH=22 STAINLESS STEEL NUT | 10.000 | PC | | | | | | | | | | |
| TB1574A | FUME CHIMNEY D30 SHOP PRO |  | TB1574A0 | FUME CHIMNEY D30 SHOP PRO | | | | | | | | | |
| TB1579A | ELENA SHOP PRO INTERNAL HUMIDITY PIPE |  | TB1579A0 | ELENA SHOP PRO INTERNAL HUMIDITY PIPE | | | | | | | | | |
| TB1638A | ELE-VIT-CAM SP WELDED EXT HUMIDITY PIPE |  | TB1638A0 | ELE-VIT-CAM SP WELDED EXT HUMIDITY PIPE | | | | | | | | | |
| VM2331A | FAN GUARD-TRAYS HOLDER PIN |  | KVM2331A | FAN GUARD-TRAYS HOLDER PIN 4 PCS KIT | <table border="1"> <thead> <tr> <th>Code</th> <th>Description</th> <th>Qty</th> <th>UOM</th> </tr> </thead> <tbody> <tr> <td>VM2331A0</td> <td>FAN GUARD-TRAY S HOLDER PIN</td> <td>4.000</td> <td>PC</td> </tr> </tbody> </table> | Code | Description | Qty | UOM | VM2331A0 | FAN GUARD-TRAY S HOLDER PIN | 4.000 | PC |
| Code | Description | Qty | UOM | | | | | | | | | | |
| VM2331A0 | FAN GUARD-TRAY S HOLDER PIN | 4.000 | PC | | | | | | | | | | |



ASM3409A/0.D02 - External cover - FRONT







ASM3409A/0.D02 - External cover - REAR





| COMPONENT | | | SPARE PART | | | | | | | | | | | | | | |
|-----------|--|-------|------------|--|---|------|-------------|-----|-----|----------|---------------------|-------|----|----------|-----------------------|-------|----|
| Code | Description | Image | Code | Description | Kit components | | | | | | | | | | | | |
| 0D2403B | DROP DOWN ELENA SP EXTERNAL CASING | | 0D2403B1 | DROP DOWN ELENA SP EXTERNAL CASING | | | | | | | | | | | | | |
| 0D2411A | SP800 INF FRONT PROFILE DROP DOWN DOOR | | 0D2411A1 | SP800 INF FRONT PROFILE DROP DOWN DOOR | | | | | | | | | | | | | |
| 0E1382A | SHOP.Pro800 EXTERNAL BOTTOM PANEL | | 0E1382A2 | SHOP.Pro800 EXTERNAL BOTTOM PANEL | | | | | | | | | | | | | |
| 0F1543B | ELENA SP BACK PANEL | | 0F1543B0 | ELENA SP BACK PANEL | | | | | | | | | | | | | |
| CR1000A | HINGE LATCH L.M. | | KCR1000A | LM HINGES LATCH KIT | <table border="1"> <thead> <tr> <th>Code</th> <th>Description</th> <th>Qty</th> <th>UOM</th> </tr> </thead> <tbody> <tr> <td>CR1000A0</td> <td>HINGE LATCH L.M.</td> <td>1.000</td> <td>PC</td> </tr> <tr> <td>VI1280A3</td> <td>M5x10 TC1/2T SCREW</td> <td>2.000</td> <td>PC</td> </tr> </tbody> </table> | Code | Description | Qty | UOM | CR1000A0 | HINGE LATCH L.M. | 1.000 | PC | VI1280A3 | M5x10 TC1/2T SCREW | 2.000 | PC |
| Code | Description | Qty | UOM | | | | | | | | | | | | | | |
| CR1000A0 | HINGE LATCH L.M. | 1.000 | PC | | | | | | | | | | | | | | |
| VI1280A3 | M5x10 TC1/2T SCREW | 2.000 | PC | | | | | | | | | | | | | | |



| COMPONENT | | | SPARE PART | | | | | | | | | | | | | | |
|-----------|---------------------------------------|---|------------|--------------------------------------|---|------|-------------|-----|-----|----------|---------------------------------------|-------|----|----------|------------------------|-------|----|
| Code | Description | Image | Code | Description | Kit components | | | | | | | | | | | | |
| VM1750A | BRASS COMB CLAM |  | KVM1750A | COMB TERMINAL BLOCK KIT | <table border="1"> <thead> <tr> <th>Code</th> <th>Description</th> <th>Qty</th> <th>UOM</th> </tr> </thead> <tbody> <tr> <td>V11040A0</td> <td>INDENTED INTERNAL WASHER D=6 ZN</td> <td>2.000</td> <td>PC</td> </tr> <tr> <td>VM1750A0</td> <td>BRASS COMB CLAMP</td> <td>1.000</td> <td>PC</td> </tr> </tbody> </table> | Code | Description | Qty | UOM | V11040A0 | INDENTED INTERNAL WASHER D=6 ZN | 2.000 | PC | VM1750A0 | BRASS COMB CLAMP | 1.000 | PC |
| Code | Description | Qty | UOM | | | | | | | | | | | | | | |
| V11040A0 | INDENTED INTERNAL WASHER D=6 ZN | 2.000 | PC | | | | | | | | | | | | | | |
| VM1750A0 | BRASS COMB CLAMP | 1.000 | PC | | | | | | | | | | | | | | |
| VM2502A | BAKERLUX SHOP.PRO CHIMNEY RING |  | KVM2502A | BAKERLUX SHOP.PRO CHIMNEY RING KIT | <table border="1"> <thead> <tr> <th>Code</th> <th>Description</th> <th>Qty</th> <th>UOM</th> </tr> </thead> <tbody> <tr> <td>VM2502A0</td> <td>BAKERLUX SHOP.PRO CHIMNEY RIN</td> <td>1.000</td> <td>PC</td> </tr> </tbody> </table> | Code | Description | Qty | UOM | VM2502A0 | BAKERLUX SHOP.PRO CHIMNEY RIN | 1.000 | PC | | | | |
| Code | Description | Qty | UOM | | | | | | | | | | | | | | |
| VM2502A0 | BAKERLUX SHOP.PRO CHIMNEY RIN | 1.000 | PC | | | | | | | | | | | | | | |
| VM2495A | SP COOLING FAN SUPPORT |  | KVM2495A | COOLING FAN SUPPORT KIT | <table border="1"> <thead> <tr> <th>Code</th> <th>Description</th> <th>Qty</th> <th>UOM</th> </tr> </thead> <tbody> <tr> <td>V11220A1</td> <td>4,2x12 TCB SELF-TAPPIN G SCREW</td> <td>2.000</td> <td>PC</td> </tr> <tr> <td>VM2495A0</td> <td>SP COOLING FAN SUPPORT</td> <td>1.000</td> <td>PC</td> </tr> </tbody> </table> | Code | Description | Qty | UOM | V11220A1 | 4,2x12 TCB SELF-TAPPIN G SCREW | 2.000 | PC | VM2495A0 | SP COOLING FAN SUPPORT | 1.000 | PC |
| Code | Description | Qty | UOM | | | | | | | | | | | | | | |
| V11220A1 | 4,2x12 TCB SELF-TAPPIN G SCREW | 2.000 | PC | | | | | | | | | | | | | | |
| VM2495A0 | SP COOLING FAN SUPPORT | 1.000 | PC | | | | | | | | | | | | | | |
| VN1175A | 230V 50/60Hz 120x120 COOLING DOWN FAN |  | KVN1175A | 120x120 230V 50/60Hz COOLING FAN KIT | <table border="1"> <thead> <tr> <th>Code</th> <th>Description</th> <th>Qty</th> <th>UOM</th> </tr> </thead> <tbody> <tr> <td>VN1175A0</td> <td>230V 50/60Hz 120x120 COOLING DOWN FAN</td> <td>1.000</td> <td>PC</td> </tr> </tbody> </table> | Code | Description | Qty | UOM | VN1175A0 | 230V 50/60Hz 120x120 COOLING DOWN FAN | 1.000 | PC | | | | |
| Code | Description | Qty | UOM | | | | | | | | | | | | | | |
| VN1175A0 | 230V 50/60Hz 120x120 COOLING DOWN FAN | 1.000 | PC | | | | | | | | | | | | | | |
| VE1295A | MK 16A 230V DOOR MICROSWITCH |  | KVE1295A | 16A 230V DOOR MICROSWITCH KIT | <table border="1"> <thead> <tr> <th>Code</th> <th>Description</th> <th>Qty</th> <th>UOM</th> </tr> </thead> <tbody> <tr> <td>VE1295A0</td> <td>MK 16A 230V DOOR MICROSWITC</td> <td>1.000</td> <td>PC</td> </tr> </tbody> </table> | Code | Description | Qty | UOM | VE1295A0 | MK 16A 230V DOOR MICROSWITC | 1.000 | PC | | | | |
| Code | Description | Qty | UOM | | | | | | | | | | | | | | |
| VE1295A0 | MK 16A 230V DOOR MICROSWITC | 1.000 | PC | | | | | | | | | | | | | | |



| COMPONENT | | | SPARE PART | | | | | | | | | | | | | | |
|-----------|---|---|------------|--|---|------|-------------|-----|-----|----------|---|--------|----|----------|--|-------|----|
| Code | Description | Image | Code | Description | Kit components | | | | | | | | | | | | |
| VM2508A | BAKERLUX SHOP.PRO DOOR SWITCH COVER |  | KVM2508A | BAKERLUX SHOP.PRO MICROSWITCH COVER KIT | <table border="1"> <thead> <tr> <th>Code</th> <th>Description</th> <th>Qty</th> <th>UOM</th> </tr> </thead> <tbody> <tr> <td>VM2508A0</td> <td>BAKERLUX SHOP.PRO DOOR SWITCH COVE</td> <td>1.000</td> <td>PC</td> </tr> </tbody> </table> | Code | Description | Qty | UOM | VM2508A0 | BAKERLUX SHOP.PRO DOOR SWITCH COVE | 1.000 | PC | | | | |
| Code | Description | Qty | UOM | | | | | | | | | | | | | | |
| VM2508A0 | BAKERLUX SHOP.PRO DOOR SWITCH COVE | 1.000 | PC | | | | | | | | | | | | | | |
| VM2481A | FRONT EXTERNAL COVER LEFT CAP S |  | KVM2481A | BL SP LEFT EXT COVER FRONT PANEL CAP KIT | <table border="1"> <thead> <tr> <th>Code</th> <th>Description</th> <th>Qty</th> <th>UOM</th> </tr> </thead> <tbody> <tr> <td>VM2481A0</td> <td>FRONT EXTERNAL COVER LEFT CAP SP</td> <td>1.000</td> <td>PC</td> </tr> </tbody> </table> | Code | Description | Qty | UOM | VM2481A0 | FRONT EXTERNAL COVER LEFT CAP SP | 1.000 | PC | | | | |
| Code | Description | Qty | UOM | | | | | | | | | | | | | | |
| VM2481A0 | FRONT EXTERNAL COVER LEFT CAP SP | 1.000 | PC | | | | | | | | | | | | | | |
| VM2480A | FRONT EXTERNAL COVER RIGHT CAP SP |  | KVM2480A | BL SP RIGHT EXT COVER FRONT PANEL CAP | <table border="1"> <thead> <tr> <th>Code</th> <th>Description</th> <th>Qty</th> <th>UOM</th> </tr> </thead> <tbody> <tr> <td>VM2480A0</td> <td>FRONT EXTERNAL COVER RIGHT CAP SP</td> <td>1.000</td> <td>PC</td> </tr> </tbody> </table> | Code | Description | Qty | UOM | VM2480A0 | FRONT EXTERNAL COVER RIGHT CAP SP | 1.000 | PC | | | | |
| Code | Description | Qty | UOM | | | | | | | | | | | | | | |
| VM2480A0 | FRONT EXTERNAL COVER RIGHT CAP SP | 1.000 | PC | | | | | | | | | | | | | | |
| VM1631A | PLUS INNER GLASS PUSHING CAP |  | KVM1631A | CAP FOR INTERNAL GLASS 10 PCS KIT | <table border="1"> <thead> <tr> <th>Code</th> <th>Description</th> <th>Qty</th> <th>UOM</th> </tr> </thead> <tbody> <tr> <td>VM1631A0</td> <td>PLUS INNER GLASS PUSHING CAP</td> <td>10.000</td> <td>PC</td> </tr> </tbody> </table> | Code | Description | Qty | UOM | VM1631A0 | PLUS INNER GLASS PUSHING CAP | 10.000 | PC | | | | |
| Code | Description | Qty | UOM | | | | | | | | | | | | | | |
| VM1631A0 | PLUS INNER GLASS PUSHING CAP | 10.000 | PC | | | | | | | | | | | | | | |
| VM2492A | BL SP 600x400 EXT BOTTOM PANEL GASKET |  | KVM2492A | SP 600X400 EXT BOT PANEL GASKET 2PC KIT | <table border="1"> <thead> <tr> <th>Code</th> <th>Description</th> <th>Qty</th> <th>UOM</th> </tr> </thead> <tbody> <tr> <td>VM1794A0</td> <td>250x4.8 PA66 BLACK CLAMP</td> <td>1.000</td> <td>PC</td> </tr> <tr> <td>VM2492A0</td> <td>BL SP 600x400 EXT BOTTOM PANEL GASKE</td> <td>2.000</td> <td>PC</td> </tr> </tbody> </table> | Code | Description | Qty | UOM | VM1794A0 | 250x4.8 PA66 BLACK CLAMP | 1.000 | PC | VM2492A0 | BL SP 600x400 EXT BOTTOM PANEL GASKE | 2.000 | PC |
| Code | Description | Qty | UOM | | | | | | | | | | | | | | |
| VM1794A0 | 250x4.8 PA66 BLACK CLAMP | 1.000 | PC | | | | | | | | | | | | | | |
| VM2492A0 | BL SP 600x400 EXT BOTTOM PANEL GASKE | 2.000 | PC | | | | | | | | | | | | | | |



| COMPONENT | | | SPARE PART | | | | | | | | | | | | | | | | | | |
|-----------|--|-------|------------|--|---|------|-------------|-----|-----|----------|--|-------|----|----------|--------------------------|-------|----|----------|--------------------------------|-------|----|
| Code | Description | Image | Code | Description | Kit components | | | | | | | | | | | | | | | | |
| VM2493A | EXT. LATERAL BACK GASKET SP800 | | KVM2493A | SP 600X400 BOT LAT PANEL GASKET 2PC KIT | <table border="1"> <thead> <tr> <th>Code</th> <th>Description</th> <th>Qty</th> <th>UOM</th> </tr> </thead> <tbody> <tr> <td>VM1631A0</td> <td>PLUS INNER GLASS PUSHING CAP</td> <td>4.000</td> <td>PC</td> </tr> <tr> <td>VM1794A0</td> <td>250x4.8 PA66 BLACK CLAMP</td> <td>1.000</td> <td>PC</td> </tr> <tr> <td>VM2493A1</td> <td>EXT. LATERAL BACK GASKET SP800</td> <td>2.000</td> <td>PC</td> </tr> </tbody> </table> | Code | Description | Qty | UOM | VM1631A0 | PLUS INNER GLASS PUSHING CAP | 4.000 | PC | VM1794A0 | 250x4.8 PA66 BLACK CLAMP | 1.000 | PC | VM2493A1 | EXT. LATERAL BACK GASKET SP800 | 2.000 | PC |
| Code | Description | Qty | UOM | | | | | | | | | | | | | | | | | | |
| VM1631A0 | PLUS INNER GLASS PUSHING CAP | 4.000 | PC | | | | | | | | | | | | | | | | | | |
| VM1794A0 | 250x4.8 PA66 BLACK CLAMP | 1.000 | PC | | | | | | | | | | | | | | | | | | |
| VM2493A1 | EXT. LATERAL BACK GASKET SP800 | 2.000 | PC | | | | | | | | | | | | | | | | | | |
| VM1222A | CABLE LOCKS SP ACCESSORIES EL CONNECTION | | VM1222A0 | CABLE LOCKS SP ACCESSORIES EL CONNECTION | | | | | | | | | | | | | | | | | |
| VM2249A | COOKING CHAMBER FRONT CORNER | | KVM2249A | CHAMBER FRONT PROFILE CORNER KIT | <table border="1"> <thead> <tr> <th>Code</th> <th>Description</th> <th>Qty</th> <th>UOM</th> </tr> </thead> <tbody> <tr> <td>VM2249A0</td> <td>COOKING CHAMBER FRONT CORNER</td> <td>1.000</td> <td>PC</td> </tr> </tbody> </table> | Code | Description | Qty | UOM | VM2249A0 | COOKING CHAMBER FRONT CORNER | 1.000 | PC | | | | | | | | |
| Code | Description | Qty | UOM | | | | | | | | | | | | | | | | | | |
| VM2249A0 | COOKING CHAMBER FRONT CORNER | 1.000 | PC | | | | | | | | | | | | | | | | | | |
| VM2455A | SP CONTROL BOARD CABLE PASS-THROUGH CLI | | KVM2455A | BL SP CONTR BOARD CABLE PASS-THROUGH KIT | <table border="1"> <thead> <tr> <th>Code</th> <th>Description</th> <th>Qty</th> <th>UOM</th> </tr> </thead> <tbody> <tr> <td>VM2455A1</td> <td>SP CONTROL BOARD CABLE PASS-THROUGH CLIP</td> <td>1.000</td> <td>PC</td> </tr> </tbody> </table> | Code | Description | Qty | UOM | VM2455A1 | SP CONTROL BOARD CABLE PASS-THROUGH CLIP | 1.000 | PC | | | | | | | | |
| Code | Description | Qty | UOM | | | | | | | | | | | | | | | | | | |
| VM2455A1 | SP CONTROL BOARD CABLE PASS-THROUGH CLIP | 1.000 | PC | | | | | | | | | | | | | | | | | | |

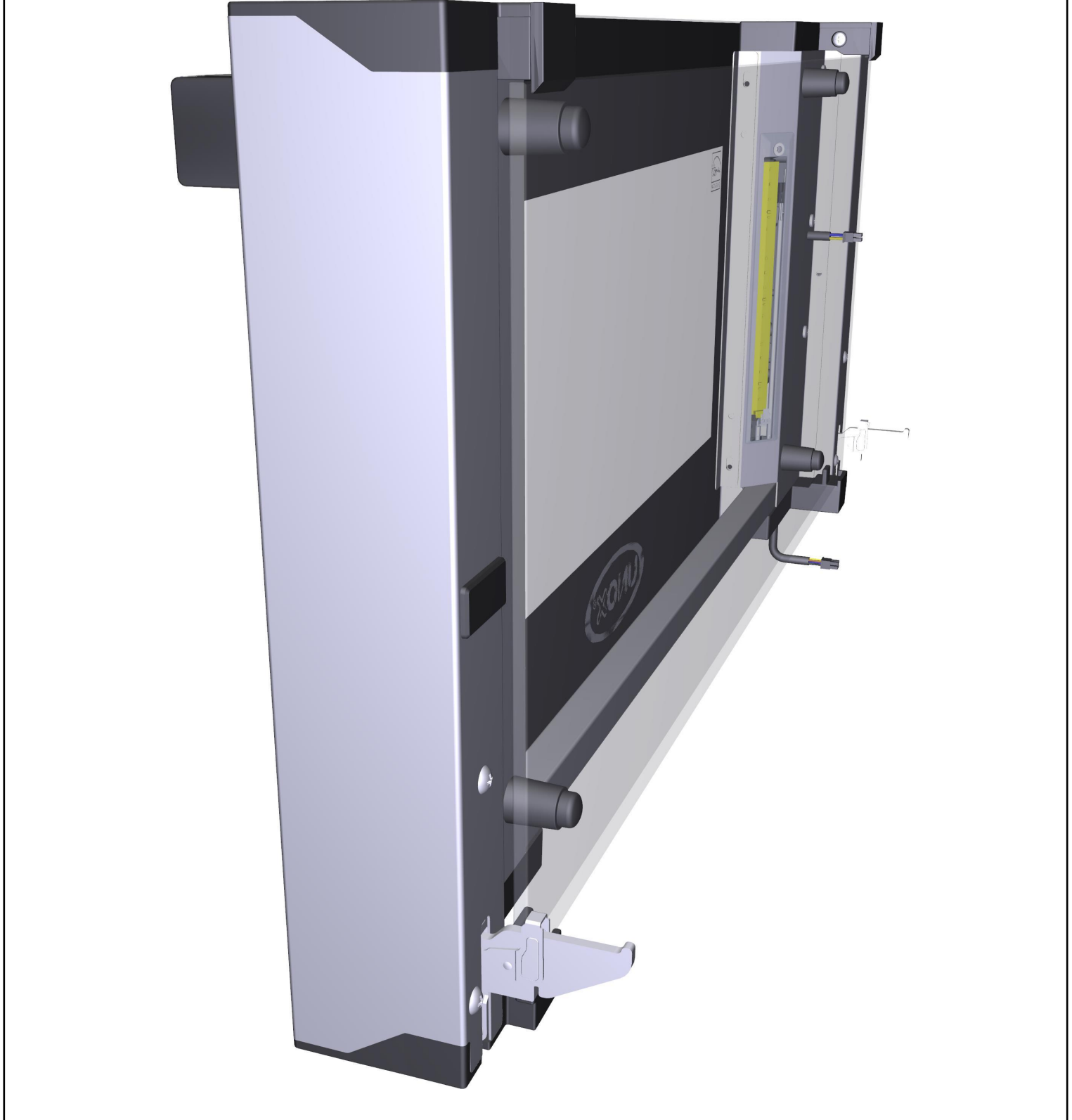

ASM3421B/0.D00 - Door - FRONT



ASM3421B/0.D00 - Door - REAR



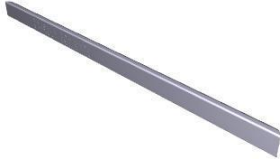

| COMPONENT | | | SPARE PART | | | | | | | | | | | | | | | | | | | | | | | | | | |
|-----------|-----------------------------------|---|------------|--|--|------|-------------|-----|-----|----------|-----------------------------------|-------|----|----------|----------------------------------|-------|----|----------|-------------------------------|-------|----|----------|--------------------------------|-------|----|----------|-----------------------------|-------|----|
| Code | Description | Image | Code | Description | Kit components | | | | | | | | | | | | | | | | | | | | | | | | |
| OB1286A | OB1286A0 |  | OB1286A0 | OB1286A0 | | | | | | | | | | | | | | | | | | | | | | | | | |
| OB1288A | OB1288A0 |  | OB1288A0 | OB1288A0 | | | | | | | | | | | | | | | | | | | | | | | | | |
| LP1050A | BL SHOP.PRO L180 COMPLETE LED BA |  | KLP1050A | L180 COMPLETE LED LIGHT BAR KIT | <table border="1"> <thead> <tr> <th>Code</th> <th>Description</th> <th>Qty</th> <th>UOM</th> </tr> </thead> <tbody> <tr> <td>LP1050A0</td> <td>BL SHOP.PRO L180 COMPLETE LED BAR</td> <td>1.000</td> <td>PC</td> </tr> <tr> <td>VI1014A0</td> <td>STAINLESS STEEL WASHER 4.5X9X0.8</td> <td>1.000</td> <td>PC</td> </tr> <tr> <td>VI1220A1</td> <td>4,2x12 TCB SELF-TAPPING SCREW</td> <td>1.000</td> <td>PC</td> </tr> </tbody> </table> | Code | Description | Qty | UOM | LP1050A0 | BL SHOP.PRO L180 COMPLETE LED BAR | 1.000 | PC | VI1014A0 | STAINLESS STEEL WASHER 4.5X9X0.8 | 1.000 | PC | VI1220A1 | 4,2x12 TCB SELF-TAPPING SCREW | 1.000 | PC | | | | | | | | |
| Code | Description | Qty | UOM | | | | | | | | | | | | | | | | | | | | | | | | | | |
| LP1050A0 | BL SHOP.PRO L180 COMPLETE LED BAR | 1.000 | PC | | | | | | | | | | | | | | | | | | | | | | | | | | |
| VI1014A0 | STAINLESS STEEL WASHER 4.5X9X0.8 | 1.000 | PC | | | | | | | | | | | | | | | | | | | | | | | | | | |
| VI1220A1 | 4,2x12 TCB SELF-TAPPING SCREW | 1.000 | PC | | | | | | | | | | | | | | | | | | | | | | | | | | |
| TB3302A | TB3302A0 |  | KTB3302A | BL SP 600X400 DROPDOWN HANDLE TUBE KIT | <table border="1"> <thead> <tr> <th>Code</th> <th>Description</th> <th>Qty</th> <th>UOM</th> </tr> </thead> <tbody> <tr> <td>TB3302A0</td> <td>TB3302A0</td> <td>1.000</td> <td>PC</td> </tr> <tr> <td>VI1147A0</td> <td>5X25 STAINLESS STEEL SCREW</td> <td>4.000</td> <td>PC</td> </tr> <tr> <td>VM2456A0</td> <td>BAKERLUX SHOP.PRO HANDLE END</td> <td>1.000</td> <td>PC</td> </tr> <tr> <td>VM2489A0</td> <td>SP HANDLE END KIT + STYLUS KIT</td> <td>1.000</td> <td>PC</td> </tr> <tr> <td>VM2527A1</td> <td>EVEREO-S.Pro DISPLAY STYLUS</td> <td>1.000</td> <td>PC</td> </tr> </tbody> </table> | Code | Description | Qty | UOM | TB3302A0 | TB3302A0 | 1.000 | PC | VI1147A0 | 5X25 STAINLESS STEEL SCREW | 4.000 | PC | VM2456A0 | BAKERLUX SHOP.PRO HANDLE END | 1.000 | PC | VM2489A0 | SP HANDLE END KIT + STYLUS KIT | 1.000 | PC | VM2527A1 | EVEREO-S.Pro DISPLAY STYLUS | 1.000 | PC |
| Code | Description | Qty | UOM | | | | | | | | | | | | | | | | | | | | | | | | | | |
| TB3302A0 | TB3302A0 | 1.000 | PC | | | | | | | | | | | | | | | | | | | | | | | | | | |
| VI1147A0 | 5X25 STAINLESS STEEL SCREW | 4.000 | PC | | | | | | | | | | | | | | | | | | | | | | | | | | |
| VM2456A0 | BAKERLUX SHOP.PRO HANDLE END | 1.000 | PC | | | | | | | | | | | | | | | | | | | | | | | | | | |
| VM2489A0 | SP HANDLE END KIT + STYLUS KIT | 1.000 | PC | | | | | | | | | | | | | | | | | | | | | | | | | | |
| VM2527A1 | EVEREO-S.Pro DISPLAY STYLUS | 1.000 | PC | | | | | | | | | | | | | | | | | | | | | | | | | | |







| COMPONENT | | | SPARE PART | | | | | | | | | | | | | | | | | | | | | | |
|---|---|---|------------|--|--|---|-------------|-----|----------|--|---|-------|----------|--|--|-------|----|----------|--|-------|----|----------|-----------------------------------|-------|----|
| Code | Description | Image | Code | Description | Kit components | | | | | | | | | | | | | | | | | | | | |
| VM2456A | BAKERLUX SHOP.PRO HANDLE END |  | KVM2456A | 2 PCS BAKERLUX SHOP.PRO HANDLE END KIT | <table border="1"> <thead> <tr> <th>Code</th> <th>Description</th> <th>Qty</th> <th>UOM</th> </tr> </thead> <tbody> <tr> <td>VI1147A0</td> <td>5X25 STAINLESS STEEL SCREW</td> <td>4.000</td> <td>PC</td> </tr> <tr> <td>VM2456A0</td> <td>BAKERLUX SHOP.PRO HANDLE END</td> <td>1.000</td> <td>PC</td> </tr> <tr> <td>VM2489A0</td> <td>SP HANDLE END KIT + STYLUS KIT</td> <td>1.000</td> <td>PC</td> </tr> <tr> <td>VM2527A1</td> <td>EVEREO-S.Pro DISPLAY STYLUS</td> <td>1.000</td> <td>PC</td> </tr> </tbody> </table> | Code | Description | Qty | UOM | VI1147A0 | 5X25 STAINLESS STEEL SCREW | 4.000 | PC | VM2456A0 | BAKERLUX SHOP.PRO HANDLE END | 1.000 | PC | VM2489A0 | SP HANDLE END KIT + STYLUS KIT | 1.000 | PC | VM2527A1 | EVEREO-S.Pro DISPLAY STYLUS | 1.000 | PC |
| | | | | | Code | Description | Qty | UOM | | | | | | | | | | | | | | | | | |
| | | | | | VI1147A0 | 5X25 STAINLESS STEEL SCREW | 4.000 | PC | | | | | | | | | | | | | | | | | |
| | | | | | VM2456A0 | BAKERLUX SHOP.PRO HANDLE END | 1.000 | PC | | | | | | | | | | | | | | | | | |
| VM2489A0 | SP HANDLE END KIT + STYLUS KIT | 1.000 | PC | | | | | | | | | | | | | | | | | | | | | | |
| VM2527A1 | EVEREO-S.Pro DISPLAY STYLUS | 1.000 | PC | | | | | | | | | | | | | | | | | | | | | | |
| <table border="1"> <thead> <tr> <th>Code</th> <th>Description</th> <th>Qty</th> <th>UOM</th> </tr> </thead> <tbody> <tr> <td>VI1998A0</td> <td>ZINC PLATED SCREW 5X30 TCB</td> <td>2.000</td> <td>PC</td> </tr> <tr> <td>VM2471A0</td> <td>BL SP LOWER CLAMP INT LOCK GLASS SLIDER</td> <td>1.000</td> <td>PC</td> </tr> <tr> <td>VM2472A0</td> <td>BL SP UPPER CLAMP INT LOCK GLASS SLIDER</td> <td>1.000</td> <td>PC</td> </tr> </tbody> </table> | Code | Description | Qty | UOM | VI1998A0 | ZINC PLATED SCREW 5X30 TCB | 2.000 | PC | VM2471A0 | BL SP LOWER CLAMP INT LOCK GLASS SLIDER | 1.000 | PC | VM2472A0 | BL SP UPPER CLAMP INT LOCK GLASS SLIDER | 1.000 | PC | | | | | | | | | |
| Code | Description | Qty | UOM | | | | | | | | | | | | | | | | | | | | | | |
| VI1998A0 | ZINC PLATED SCREW 5X30 TCB | 2.000 | PC | | | | | | | | | | | | | | | | | | | | | | |
| VM2471A0 | BL SP LOWER CLAMP INT LOCK GLASS SLIDER | 1.000 | PC | | | | | | | | | | | | | | | | | | | | | | |
| VM2472A0 | BL SP UPPER CLAMP INT LOCK GLASS SLIDER | 1.000 | PC | | | | | | | | | | | | | | | | | | | | | | |
| <table border="1"> <thead> <tr> <th>Code</th> <th>Description</th> <th>Qty</th> <th>UOM</th> </tr> </thead> <tbody> <tr> <td>VM2503A0</td> <td>SLIDE TO FIX INTERNAL NON REMOV GLASS SP</td> <td>2.000</td> <td>PC</td> </tr> </tbody> </table> | Code | Description | Qty | UOM | VM2503A0 | SLIDE TO FIX INTERNAL NON REMOV GLASS SP | 2.000 | PC | | | | | | | | | | | | | | | | | |
| Code | Description | Qty | UOM | | | | | | | | | | | | | | | | | | | | | | |
| VM2503A0 | SLIDE TO FIX INTERNAL NON REMOV GLASS SP | 2.000 | PC | | | | | | | | | | | | | | | | | | | | | | |
| <table border="1"> <thead> <tr> <th>Code</th> <th>Description</th> <th>Qty</th> <th>UOM</th> </tr> </thead> <tbody> <tr> <td>VM2464A0</td> <td>SHOP.PRO LEFT UPPER CAP DROP DOWN DOOR</td> <td>1.000</td> <td>PC</td> </tr> </tbody> </table> | Code | Description | Qty | UOM | VM2464A0 | SHOP.PRO LEFT UPPER CAP DROP DOWN DOOR | 1.000 | PC | | | | | | | | | | | | | | | | | |
| Code | Description | Qty | UOM | | | | | | | | | | | | | | | | | | | | | | |
| VM2464A0 | SHOP.PRO LEFT UPPER CAP DROP DOWN DOOR | 1.000 | PC | | | | | | | | | | | | | | | | | | | | | | |
| VM2471A | BL SP LOWER CLAMP INT LOCK GLASS SLIDER |  | KVM2471A | BL SP INTERNAL GLASS LOCK HOLDER KIT | <table border="1"> <thead> <tr> <th>Code</th> <th>Description</th> <th>Qty</th> <th>UOM</th> </tr> </thead> <tbody> <tr> <td>VI1998A0</td> <td>ZINC PLATED SCREW 5X30 TCB</td> <td>2.000</td> <td>PC</td> </tr> <tr> <td>VM2471A0</td> <td>BL SP LOWER CLAMP INT LOCK GLASS SLIDER</td> <td>1.000</td> <td>PC</td> </tr> <tr> <td>VM2472A0</td> <td>BL SP UPPER CLAMP INT LOCK GLASS SLIDER</td> <td>1.000</td> <td>PC</td> </tr> </tbody> </table> | Code | Description | Qty | UOM | VI1998A0 | ZINC PLATED SCREW 5X30 TCB | 2.000 | PC | VM2471A0 | BL SP LOWER CLAMP INT LOCK GLASS SLIDER | 1.000 | PC | VM2472A0 | BL SP UPPER CLAMP INT LOCK GLASS SLIDER | 1.000 | PC | | | | |
| Code | Description | Qty | UOM | | | | | | | | | | | | | | | | | | | | | | |
| VI1998A0 | ZINC PLATED SCREW 5X30 TCB | 2.000 | PC | | | | | | | | | | | | | | | | | | | | | | |
| VM2471A0 | BL SP LOWER CLAMP INT LOCK GLASS SLIDER | 1.000 | PC | | | | | | | | | | | | | | | | | | | | | | |
| VM2472A0 | BL SP UPPER CLAMP INT LOCK GLASS SLIDER | 1.000 | PC | | | | | | | | | | | | | | | | | | | | | | |
| VM2503A | SLIDE TO FIX INTERNAL NON REMOV GLASS SP |  | KVM2503A | BL SP INT FIXED GLASS LOCK 2 PCS KIT | <table border="1"> <thead> <tr> <th>Code</th> <th>Description</th> <th>Qty</th> <th>UOM</th> </tr> </thead> <tbody> <tr> <td>VM2503A0</td> <td>SLIDE TO FIX INTERNAL NON REMOV GLASS SP</td> <td>2.000</td> <td>PC</td> </tr> </tbody> </table> | Code | Description | Qty | UOM | VM2503A0 | SLIDE TO FIX INTERNAL NON REMOV GLASS SP | 2.000 | PC | | | | | | | | | | | | |
| Code | Description | Qty | UOM | | | | | | | | | | | | | | | | | | | | | | |
| VM2503A0 | SLIDE TO FIX INTERNAL NON REMOV GLASS SP | 2.000 | PC | | | | | | | | | | | | | | | | | | | | | | |
| VM2464A | SHOP.PRO LEFT UPPER CAP DROP DOWN DOOR |  | KVM2464A | BL SP LEFT UPPER DROPDOWN DOOR CAP KIT | <table border="1"> <thead> <tr> <th>Code</th> <th>Description</th> <th>Qty</th> <th>UOM</th> </tr> </thead> <tbody> <tr> <td>VM2464A0</td> <td>SHOP.PRO LEFT UPPER CAP DROP DOWN DOOR</td> <td>1.000</td> <td>PC</td> </tr> </tbody> </table> | Code | Description | Qty | UOM | VM2464A0 | SHOP.PRO LEFT UPPER CAP DROP DOWN DOOR | 1.000 | PC | | | | | | | | | | | | |
| Code | Description | Qty | UOM | | | | | | | | | | | | | | | | | | | | | | |
| VM2464A0 | SHOP.PRO LEFT UPPER CAP DROP DOWN DOOR | 1.000 | PC | | | | | | | | | | | | | | | | | | | | | | |



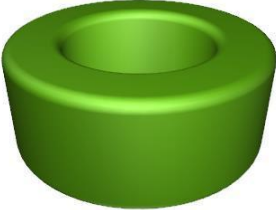

| COMPONENT | | | SPARE PART | | | | | | | | | | | | | | | | | | |
|-----------|---|---|------------|---|---|------|-------------|-----|-----|----------|---|-------|----|----------|--|-------|----|----------|--|-------|----|
| Code | Description | Image | Code | Description | Kit components | | | | | | | | | | | | | | | | |
| VM2472A | BL SP UPPER CLAMP INT LOCK GLASS SLIDER |  | KVM2471A | BL SP INTERNAL GLASS LOCK HOLDER KIT | <table border="1"> <thead> <tr> <th>Code</th> <th>Description</th> <th>Qty</th> <th>UOM</th> </tr> </thead> <tbody> <tr> <td>V11998A0</td> <td>ZINC PLATED SCREW 5X30 TCB</td> <td>2.000</td> <td>PC</td> </tr> <tr> <td>VM2471A0</td> <td>BL SP LOWER CLAMP INT LOCK GLASS SLIDER</td> <td>1.000</td> <td>PC</td> </tr> <tr> <td>VM2472A0</td> <td>BL SP UPPER CLAMP INT LOCK GLASS SLIDER</td> <td>1.000</td> <td>PC</td> </tr> </tbody> </table> | Code | Description | Qty | UOM | V11998A0 | ZINC PLATED SCREW 5X30 TCB | 2.000 | PC | VM2471A0 | BL SP LOWER CLAMP INT LOCK GLASS SLIDER | 1.000 | PC | VM2472A0 | BL SP UPPER CLAMP INT LOCK GLASS SLIDER | 1.000 | PC |
| Code | Description | Qty | UOM | | | | | | | | | | | | | | | | | | |
| V11998A0 | ZINC PLATED SCREW 5X30 TCB | 2.000 | PC | | | | | | | | | | | | | | | | | | |
| VM2471A0 | BL SP LOWER CLAMP INT LOCK GLASS SLIDER | 1.000 | PC | | | | | | | | | | | | | | | | | | |
| VM2472A0 | BL SP UPPER CLAMP INT LOCK GLASS SLIDER | 1.000 | PC | | | | | | | | | | | | | | | | | | |
| VM2503A | SLIDE TO FIX INTERNAL NON REMOV GLASS SP |  | KVM2503A | BL SP INT FIXED GLASS LOCK 2 PCS KIT | <table border="1"> <thead> <tr> <th>Code</th> <th>Description</th> <th>Qty</th> <th>UOM</th> </tr> </thead> <tbody> <tr> <td>VM2503A0</td> <td>SLIDE TO FIX INTERNAL NON REMOV GLASS SP</td> <td>2.000</td> <td>PC</td> </tr> </tbody> </table> | Code | Description | Qty | UOM | VM2503A0 | SLIDE TO FIX INTERNAL NON REMOV GLASS SP | 2.000 | PC | | | | | | | | |
| Code | Description | Qty | UOM | | | | | | | | | | | | | | | | | | |
| VM2503A0 | SLIDE TO FIX INTERNAL NON REMOV GLASS SP | 2.000 | PC | | | | | | | | | | | | | | | | | | |
| VM2463A | SHOP.PRO RIGHT UPPER CAP DROP DOWN DOOR |  | KVM2463A | BL SP RIGHT UPPER DROPDOWN DOOR CAP KIT | <table border="1"> <thead> <tr> <th>Code</th> <th>Description</th> <th>Qty</th> <th>UOM</th> </tr> </thead> <tbody> <tr> <td>VM2463A0</td> <td>SHOP.PRO RIGHT UPPER CAP DROP DOWN DOOR</td> <td>1.000</td> <td>PC</td> </tr> </tbody> </table> | Code | Description | Qty | UOM | VM2463A0 | SHOP.PRO RIGHT UPPER CAP DROP DOWN DOOR | 1.000 | PC | | | | | | | | |
| Code | Description | Qty | UOM | | | | | | | | | | | | | | | | | | |
| VM2463A0 | SHOP.PRO RIGHT UPPER CAP DROP DOWN DOOR | 1.000 | PC | | | | | | | | | | | | | | | | | | |
| TB1563A | DOOR LATERAL BEAM SP800 |  | TB1563A0 | DOOR LATERAL BEAM SP800 | | | | | | | | | | | | | | | | | |
| VI1174A | VI1174A0 |  | VI1174A0 | VI1174A0 | | | | | | | | | | | | | | | | | |



| COMPONENT | | | SPARE PART | | | | | | | | | | | | | | |
|-----------|---|--------|------------|---|---|------|-------------|-----|-----|----------|---|--------|----|----------|--------------------------------|-------|----|
| Code | Description | Image | Code | Description | Kit components | | | | | | | | | | | | |
| VM2461A | BL SP RIGHT LOWER DROPDOWN DOOR CAP KIT | | KVM2461A | BL SP RIGHT LOWER DROPDOWN DOOR CAP KIT | <table border="1"> <thead> <tr> <th>Code</th> <th>Description</th> <th>Qty</th> <th>UOM</th> </tr> </thead> <tbody> <tr> <td>VM2461A0</td> <td>BL SP RIGHT LOWER DROPDOWN DOOR CAP KIT</td> <td>1.000</td> <td>PC</td> </tr> </tbody> </table> | Code | Description | Qty | UOM | VM2461A0 | BL SP RIGHT LOWER DROPDOWN DOOR CAP KIT | 1.000 | PC | | | | |
| Code | Description | Qty | UOM | | | | | | | | | | | | | | |
| VM2461A0 | BL SP RIGHT LOWER DROPDOWN DOOR CAP KIT | 1.000 | PC | | | | | | | | | | | | | | |
| VM2462A | BL SP LEFT LOWER DROPDOWN DOOR CAP | | KVM2462A | BL SP LEFT LOWER DROPDOWN DOOR CAP KIT | <table border="1"> <thead> <tr> <th>Code</th> <th>Description</th> <th>Qty</th> <th>UOM</th> </tr> </thead> <tbody> <tr> <td>VM2462A0</td> <td>BL SP LEFT LOWER DROPDOWN DOOR CAP</td> <td>1.000</td> <td>PC</td> </tr> </tbody> </table> | Code | Description | Qty | UOM | VM2462A0 | BL SP LEFT LOWER DROPDOWN DOOR CAP | 1.000 | PC | | | | |
| Code | Description | Qty | UOM | | | | | | | | | | | | | | |
| VM2462A0 | BL SP LEFT LOWER DROPDOWN DOOR CAP | 1.000 | PC | | | | | | | | | | | | | | |
| VM1630A | INTERNAL GLASS PUSHING CAP | | KVM1630A | CAP FOR INTERNAL GLASS 10 PCS KIT | <table border="1"> <thead> <tr> <th>Code</th> <th>Description</th> <th>Qty</th> <th>UOM</th> </tr> </thead> <tbody> <tr> <td>VM1630A1</td> <td>INTERNAL GLASS PUSHING CAP</td> <td>10.000</td> <td>PC</td> </tr> </tbody> </table> | Code | Description | Qty | UOM | VM1630A1 | INTERNAL GLASS PUSHING CAP | 10.000 | PC | | | | |
| Code | Description | Qty | UOM | | | | | | | | | | | | | | |
| VM1630A1 | INTERNAL GLASS PUSHING CAP | 10.000 | PC | | | | | | | | | | | | | | |
| VM2479A | BL SP GLASS H6 PUSHING BRACKET | | KVM2479A | BL SHOP.PRO H6 GLASS SUPPORT 6 PCS KIT | <table border="1"> <thead> <tr> <th>Code</th> <th>Description</th> <th>Qty</th> <th>UOM</th> </tr> </thead> <tbody> <tr> <td>VM1630A1</td> <td>INTERNAL GLASS PUSHING CAP</td> <td>6.000</td> <td>PC</td> </tr> <tr> <td>VM2479A0</td> <td>BL SP GLASS H6 PUSHING BRACKET</td> <td>6.000</td> <td>PC</td> </tr> </tbody> </table> | Code | Description | Qty | UOM | VM1630A1 | INTERNAL GLASS PUSHING CAP | 6.000 | PC | VM2479A0 | BL SP GLASS H6 PUSHING BRACKET | 6.000 | PC |
| Code | Description | Qty | UOM | | | | | | | | | | | | | | |
| VM1630A1 | INTERNAL GLASS PUSHING CAP | 6.000 | PC | | | | | | | | | | | | | | |
| VM2479A0 | BL SP GLASS H6 PUSHING BRACKET | 6.000 | PC | | | | | | | | | | | | | | |
| CE1095A | 4 POLES MICROFIT 2 M BUS CABLE | | KCE1095A | 4POLES 2M BUS CABLE KIT POWER-CONTROL | <table border="1"> <thead> <tr> <th>Code</th> <th>Description</th> <th>Qty</th> <th>UOM</th> </tr> </thead> <tbody> <tr> <td>CE1095A0</td> <td>4 POLES MICROFIT 2 M BUS CABLE</td> <td>1.000</td> <td>PC</td> </tr> </tbody> </table> | Code | Description | Qty | UOM | CE1095A0 | 4 POLES MICROFIT 2 M BUS CABLE | 1.000 | PC | | | | |
| Code | Description | Qty | UOM | | | | | | | | | | | | | | |
| CE1095A0 | 4 POLES MICROFIT 2 M BUS CABLE | 1.000 | PC | | | | | | | | | | | | | | |

| COMPONENT | | | SPARE PART | | | | | | | | | | | | | | | | | | |
|-----------|--|---|------------|--|---|------|-------------|-----|-----|----------|--|-------|----|----------|----------------------------------|-------|----|----------|--|-------|----|
| Code | Description | Image | Code | Description | Kit components | | | | | | | | | | | | | | | | |
| CE1285A | EMI ROUND FERRITE MOD.2643801502 |  | KCE1285A | ROUND FERRITE ELECTROMAGN PROT. 2PCS KIT | <table border="1"> <thead> <tr> <th>Code</th> <th>Description</th> <th>Qty</th> <th>UOM</th> </tr> </thead> <tbody> <tr> <td>CE1285A0</td> <td>EMI ROUND FERRITE MOD.2643801502</td> <td>2.000</td> <td>PC</td> </tr> </tbody> </table> | Code | Description | Qty | UOM | CE1285A0 | EMI ROUND FERRITE MOD.2643801502 | 2.000 | PC | | | | | | | | |
| Code | Description | Qty | UOM | | | | | | | | | | | | | | | | | | |
| CE1285A0 | EMI ROUND FERRITE MOD.2643801502 | 2.000 | PC | | | | | | | | | | | | | | | | | | |
| CR1112A | CR1112A1 |  | KCR1112A | BAKERLUX SP ARIANNA-ELENA HINGE KIT | <table border="1"> <thead> <tr> <th>Code</th> <th>Description</th> <th>Qty</th> <th>UOM</th> </tr> </thead> <tbody> <tr> <td>CR1112A1</td> <td>CR1112A1</td> <td>1.000</td> <td>PC</td> </tr> <tr> <td>VI1280A3</td> <td>M5x10 TC1/2T SCREW</td> <td>3.000</td> <td>PC</td> </tr> </tbody> </table> | Code | Description | Qty | UOM | CR1112A1 | CR1112A1 | 1.000 | PC | VI1280A3 | M5x10 TC1/2T SCREW | 3.000 | PC | | | | |
| Code | Description | Qty | UOM | | | | | | | | | | | | | | | | | | |
| CR1112A1 | CR1112A1 | 1.000 | PC | | | | | | | | | | | | | | | | | | |
| VI1280A3 | M5x10 TC1/2T SCREW | 3.000 | PC | | | | | | | | | | | | | | | | | | |
| PE2107A | BAKERLUX SHOP.PRO LED COMPLETE CONTROL |  | KPE2107A | BAKERLUX SP LED CONTROL BOARD KIT | <table border="1"> <thead> <tr> <th>Code</th> <th>Description</th> <th>Qty</th> <th>UOM</th> </tr> </thead> <tbody> <tr> <td>PE2107A2</td> <td>BAKERLUX SHOP.PRO LED COMPLETE CONTROL</td> <td>1.000</td> <td>PC</td> </tr> <tr> <td>VI1147A0</td> <td>5X25 STAINLESS STEEL SCREW</td> <td>2.000</td> <td>PC</td> </tr> <tr> <td>VM1447A0</td> <td></td> <td>1.000</td> <td>PC</td> </tr> </tbody> </table> | Code | Description | Qty | UOM | PE2107A2 | BAKERLUX SHOP.PRO LED COMPLETE CONTROL | 1.000 | PC | VI1147A0 | 5X25 STAINLESS STEEL SCREW | 2.000 | PC | VM1447A0 | | 1.000 | PC |
| Code | Description | Qty | UOM | | | | | | | | | | | | | | | | | | |
| PE2107A2 | BAKERLUX SHOP.PRO LED COMPLETE CONTROL | 1.000 | PC | | | | | | | | | | | | | | | | | | |
| VI1147A0 | 5X25 STAINLESS STEEL SCREW | 2.000 | PC | | | | | | | | | | | | | | | | | | |
| VM1447A0 | | 1.000 | PC | | | | | | | | | | | | | | | | | | |
| VI1174A | VI1174A0 |  | VI1174A0 | VI1174A0 | | | | | | | | | | | | | | | | | |
| VM2512A | BL SP DOOR-MICROSWITC H SOFT CLOSING |  | KVM2512A | BL SP DOOR-MICROSWITC H SOFT CLOSING KI | <table border="1"> <thead> <tr> <th>Code</th> <th>Description</th> <th>Qty</th> <th>UOM</th> </tr> </thead> <tbody> <tr> <td>VM2512A0</td> <td>BL SP DOOR-MICRO SWITCH SOFT CLOSING</td> <td>1.000</td> <td>PC</td> </tr> </tbody> </table> | Code | Description | Qty | UOM | VM2512A0 | BL SP DOOR-MICRO SWITCH SOFT CLOSING | 1.000 | PC | | | | | | | | |
| Code | Description | Qty | UOM | | | | | | | | | | | | | | | | | | |
| VM2512A0 | BL SP DOOR-MICRO SWITCH SOFT CLOSING | 1.000 | PC | | | | | | | | | | | | | | | | | | |



| COMPONENT | | | SPARE PART | | | | | | | | | | | | | | | | | | | | | | |
|-----------|--|--|------------|---|--|-------------|-------------|-----|-----|----------|---|-------|----|----------|--|-------|----|----------|--------------------------------------|-------|----|----------|--|-------|----|
| Code | Description | Image | Code | Description | Kit components | | | | | | | | | | | | | | | | | | | | |
| VT1219A | 557x364x4 SP ELENA BLACK EXTERNAL GLASS |  | KVT1219A | ELENA BL SPRO EXT BLACK GLASS KIT | <table border="1"> <thead> <tr> <th>Code</th> <th>Description</th> <th>Qty</th> <th>UOM</th> </tr> </thead> <tbody> <tr> <td>0B0386A0</td> <td>SP STE-ELE EXT GLASS SUPPORT PROFILE</td> <td>2.000</td> <td>PC</td> </tr> <tr> <td>SL1185A1</td> <td></td> <td>2.000</td> <td>PC</td> </tr> <tr> <td>VI1220A1</td> <td>4,2x12 TCB SELF-TAPPIN G SCREW</td> <td>6.000</td> <td>PC</td> </tr> <tr> <td>VT1219A0</td> <td>557x364x4 SP ELENA BLACK EXTERNAL GLASS</td> <td>1.000</td> <td>PC</td> </tr> </tbody> </table> | Code | Description | Qty | UOM | 0B0386A0 | SP STE-ELE EXT GLASS SUPPORT PROFILE | 2.000 | PC | SL1185A1 | | 2.000 | PC | VI1220A1 | 4,2x12 TCB SELF-TAPPIN G SCREW | 6.000 | PC | VT1219A0 | 557x364x4 SP ELENA BLACK EXTERNAL GLASS | 1.000 | PC |
| | | | | | Code | Description | Qty | UOM | | | | | | | | | | | | | | | | | |
| 0B0386A0 | SP STE-ELE EXT GLASS SUPPORT PROFILE | 2.000 | PC | | | | | | | | | | | | | | | | | | | | | | |
| SL1185A1 | | 2.000 | PC | | | | | | | | | | | | | | | | | | | | | | |
| VI1220A1 | 4,2x12 TCB SELF-TAPPIN G SCREW | 6.000 | PC | | | | | | | | | | | | | | | | | | | | | | |
| VT1219A0 | 557x364x4 SP ELENA BLACK EXTERNAL GLASS | 1.000 | PC | | | | | | | | | | | | | | | | | | | | | | |
| VT1331A | SP ELENA 715x318.5x6 INNER GLASS |  | KVT1331A | BL SP ELENA DOOR INNER GLASS KIT | <table border="1"> <thead> <tr> <th>Code</th> <th>Description</th> <th>Qty</th> <th>UOM</th> </tr> </thead> <tbody> <tr> <td>VT1331A0</td> <td>SP ELENA 715x318.5x6 INNER GLASS</td> <td>1.000</td> <td>PC</td> </tr> </tbody> </table> | Code | Description | Qty | UOM | VT1331A0 | SP ELENA 715x318.5x6 INNER GLASS | 1.000 | PC | | | | | | | | | | | | |
| Code | Description | Qty | UOM | | | | | | | | | | | | | | | | | | | | | | |
| VT1331A0 | SP ELENA 715x318.5x6 INNER GLASS | 1.000 | PC | | | | | | | | | | | | | | | | | | | | | | |

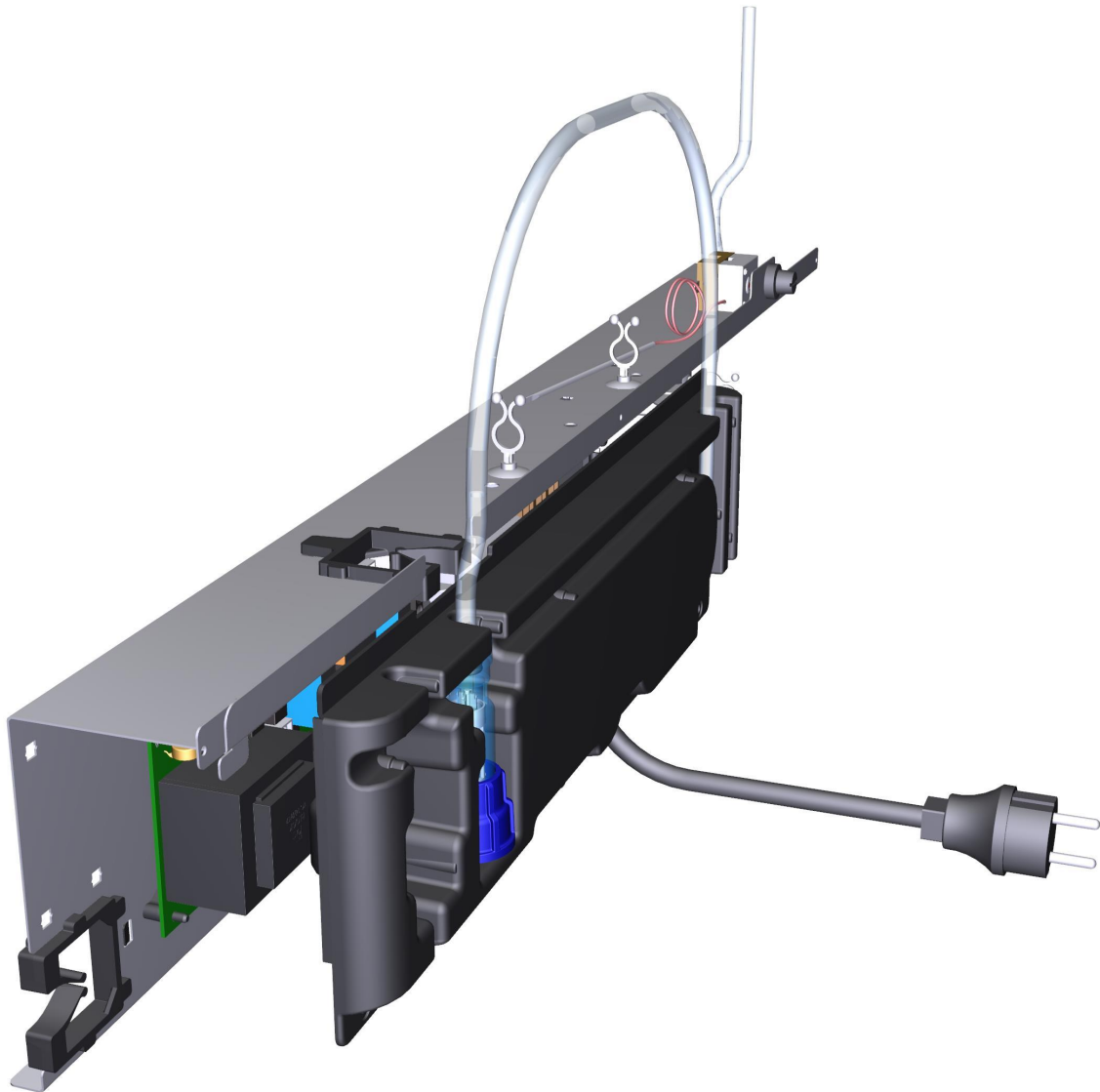

ASM8226A/0.D00 - Electrical system - FRONT





ASM8226A/0.D00 - Electrical system - REAR

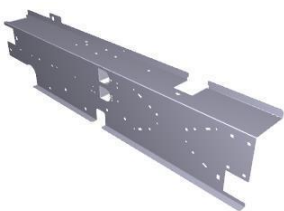
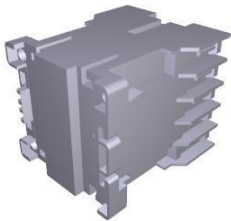

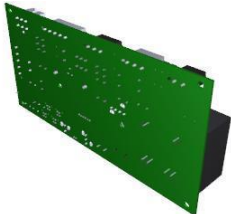



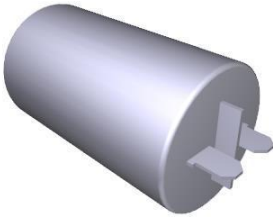
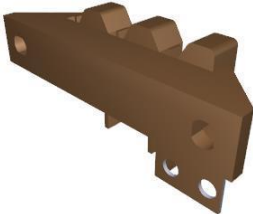

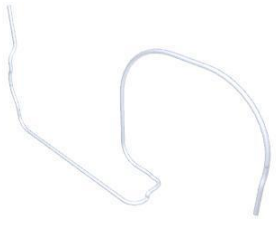

| COMPONENT | | | SPARE PART | | | | | | | | | | | | | | | | | | | | | | | | | | |
|-----------|---------------------------------------|---|------------|---|--|------|-------------|-----|-----|----------|-------------------------------------|-------|----|----------|---------------------------------------|-------|----|----------|----------------------------|-------|----|----------|--|-------|----|----------|-----------------------------------|-------|----|
| Code | Description | Image | Code | Description | Kit components | | | | | | | | | | | | | | | | | | | | | | | | |
| 0P1032A | SP ELE-ROS EL COMPONENTS HOLDER |  | 0P1032A0 | SP ELE-ROS EL COMPONENTS HOLDER | | | | | | | | | | | | | | | | | | | | | | | | | |
| VE1115A | 20 A 230V 4 POLES MINICONTRACTOR |  | KVE1115A | 20A 230V 4 POLES MINICONTRACTOR KI | <table border="1"> <thead> <tr> <th>Code</th> <th>Description</th> <th>Qty</th> <th>UOM</th> </tr> </thead> <tbody> <tr> <td>VE1115A0</td> <td>20 A 230V 4 POLES MINICONTRACTOR OR</td> <td>1.000</td> <td>PC</td> </tr> <tr> <td>VM1075A1</td> <td>PLASTIC CLIP TO FIX CONTACTORS</td> <td>4.000</td> <td>PC</td> </tr> </tbody> </table> | Code | Description | Qty | UOM | VE1115A0 | 20 A 230V 4 POLES MINICONTRACTOR OR | 1.000 | PC | VM1075A1 | PLASTIC CLIP TO FIX CONTACTORS | 4.000 | PC | | | | | | | | | | | | |
| Code | Description | Qty | UOM | | | | | | | | | | | | | | | | | | | | | | | | | | |
| VE1115A0 | 20 A 230V 4 POLES MINICONTRACTOR OR | 1.000 | PC | | | | | | | | | | | | | | | | | | | | | | | | | | |
| VM1075A1 | PLASTIC CLIP TO FIX CONTACTORS | 4.000 | PC | | | | | | | | | | | | | | | | | | | | | | | | | | |
| VM1056A | SMALL CONTACTOR BRACKET VE1115A |  | VM1056A0 | SMALL CONTACTOR BRACKET VE1115A | | | | | | | | | | | | | | | | | | | | | | | | | |
| VL1145A | VL1145A1 |  | KVL1145A | 3/4-JG8 FITTING WITH FILTER AND NRV KIT | <table border="1"> <thead> <tr> <th>Code</th> <th>Description</th> <th>Qty</th> <th>UOM</th> </tr> </thead> <tbody> <tr> <td>VL1145A1</td> <td>VL1145A1</td> <td>1.000</td> <td>PC</td> </tr> </tbody> </table> | Code | Description | Qty | UOM | VL1145A1 | VL1145A1 | 1.000 | PC | | | | | | | | | | | | | | | | |
| Code | Description | Qty | UOM | | | | | | | | | | | | | | | | | | | | | | | | | | |
| VL1145A1 | VL1145A1 | 1.000 | PC | | | | | | | | | | | | | | | | | | | | | | | | | | |
| PE2260A | BL SHOP.PRO 230V POWER BOARD |  | KPE2260A | BL SHOP.PRO 230V POWER CARD KIT | <table border="1"> <thead> <tr> <th>Code</th> <th>Description</th> <th>Qty</th> <th>UOM</th> </tr> </thead> <tbody> <tr> <td>PE2260A1</td> <td>BL SHOP.PRO 230V POWER BOARD</td> <td>1.000</td> <td>PC</td> </tr> <tr> <td>V1988A0</td> <td>AUTOTHREAD ING SCREW 4,2x19 TCB+ INOX</td> <td>3.000</td> <td>PC</td> </tr> <tr> <td>VM1187A0</td> <td>POWER BOARD FRAME SHOP.PRO</td> <td>1.000</td> <td>PC</td> </tr> <tr> <td>VM1447A0</td> <td></td> <td>1.000</td> <td>PC</td> </tr> <tr> <td>VM1748A0</td> <td>JOINT-JOINT H10 BOARD FIXING CLIP</td> <td>6.000</td> <td>PC</td> </tr> </tbody> </table> | Code | Description | Qty | UOM | PE2260A1 | BL SHOP.PRO 230V POWER BOARD | 1.000 | PC | V1988A0 | AUTOTHREAD ING SCREW 4,2x19 TCB+ INOX | 3.000 | PC | VM1187A0 | POWER BOARD FRAME SHOP.PRO | 1.000 | PC | VM1447A0 | | 1.000 | PC | VM1748A0 | JOINT-JOINT H10 BOARD FIXING CLIP | 6.000 | PC |
| Code | Description | Qty | UOM | | | | | | | | | | | | | | | | | | | | | | | | | | |
| PE2260A1 | BL SHOP.PRO 230V POWER BOARD | 1.000 | PC | | | | | | | | | | | | | | | | | | | | | | | | | | |
| V1988A0 | AUTOTHREAD ING SCREW 4,2x19 TCB+ INOX | 3.000 | PC | | | | | | | | | | | | | | | | | | | | | | | | | | |
| VM1187A0 | POWER BOARD FRAME SHOP.PRO | 1.000 | PC | | | | | | | | | | | | | | | | | | | | | | | | | | |
| VM1447A0 | | 1.000 | PC | | | | | | | | | | | | | | | | | | | | | | | | | | |
| VM1748A0 | JOINT-JOINT H10 BOARD FIXING CLIP | 6.000 | PC | | | | | | | | | | | | | | | | | | | | | | | | | | |

| COMPONENT | | | SPARE PART | | | | | | | | | | | | | | | | | | |
|-----------|---|---|------------|---|--|------|-------------|-----|-----|----------|---|--------|----|----------|---------------------------------------|-------|----|----------|--------------------------------------|-------|----|
| Code | Description | Image | Code | Description | Kit components | | | | | | | | | | | | | | | | |
| VM1187A | POWER BOARD FRAME SHOP.PRO |  | VM1187A0 | POWER BOARD FRAME SHOP.PRO | | | | | | | | | | | | | | | | | |
| CE1581A | CABLE H07RNF 3G1.5 L1.5MT+K1/6+SCHU KO |  | KCE1581A | H07RNF 3G1.5 L1.5 MT + SHUKO PLUG KIT | <table border="1"> <thead> <tr> <th>Code</th> <th>Description</th> <th>Qty</th> <th>UOM</th> </tr> </thead> <tbody> <tr> <td>CE1581A0</td> <td>CABLE H07RNF 3G1.5 L1.5MT+K1/6+ SCHUKO</td> <td>1.000</td> <td>PC</td> </tr> </tbody> </table> | Code | Description | Qty | UOM | CE1581A0 | CABLE H07RNF 3G1.5 L1.5MT+K1/6+ SCHUKO | 1.000 | PC | | | | | | | | |
| Code | Description | Qty | UOM | | | | | | | | | | | | | | | | | | |
| CE1581A0 | CABLE H07RNF 3G1.5 L1.5MT+K1/6+ SCHUKO | 1.000 | PC | | | | | | | | | | | | | | | | | | |
| CN1003A | 6,3 Uf MOTOR CAPACITOR |  | KCN1003A | 6,3 uF MOTOR CAPACITOR KIT | <table border="1"> <thead> <tr> <th>Code</th> <th>Description</th> <th>Qty</th> <th>UOM</th> </tr> </thead> <tbody> <tr> <td>CN1003A0</td> <td>6,3 Uf MOTOR CAPACITOR</td> <td>1.000</td> <td>PC</td> </tr> <tr> <td>V11931A0</td> <td>M8x1.65 H4 CH13 ZINC PLATED NUT</td> <td>1.000</td> <td>PC</td> </tr> <tr> <td>V11932A0</td> <td>D8 INDENTED ZINC PLATED WASHER</td> <td>1.000</td> <td>PC</td> </tr> </tbody> </table> | Code | Description | Qty | UOM | CN1003A0 | 6,3 Uf MOTOR CAPACITOR | 1.000 | PC | V11931A0 | M8x1.65 H4 CH13 ZINC PLATED NUT | 1.000 | PC | V11932A0 | D8 INDENTED ZINC PLATED WASHER | 1.000 | PC |
| Code | Description | Qty | UOM | | | | | | | | | | | | | | | | | | |
| CN1003A0 | 6,3 Uf MOTOR CAPACITOR | 1.000 | PC | | | | | | | | | | | | | | | | | | |
| V11931A0 | M8x1.65 H4 CH13 ZINC PLATED NUT | 1.000 | PC | | | | | | | | | | | | | | | | | | |
| V11932A0 | D8 INDENTED ZINC PLATED WASHER | 1.000 | PC | | | | | | | | | | | | | | | | | | |
| MR1025A | 3 POLES 450V 41A+GROUND TERMINAL BLOCK |  | KMR1025A | 3 POLES TERMINAL BLOCK KIT | <table border="1"> <thead> <tr> <th>Code</th> <th>Description</th> <th>Qty</th> <th>UOM</th> </tr> </thead> <tbody> <tr> <td>MR1025A1</td> <td>3 POLES 450V 41A+GROUND TERMINAL BLOCK</td> <td>1.000</td> <td>PC</td> </tr> </tbody> </table> | Code | Description | Qty | UOM | MR1025A1 | 3 POLES 450V 41A+GROUND TERMINAL BLOCK | 1.000 | PC | | | | | | | | |
| Code | Description | Qty | UOM | | | | | | | | | | | | | | | | | | |
| MR1025A1 | 3 POLES 450V 41A+GROUND TERMINAL BLOCK | 1.000 | PC | | | | | | | | | | | | | | | | | | |
| RC1006A | D8 PET PIPE GUIDE BEND |  | KRC1006A | 20 PCS. Ø8 PET PIPE GUIDE BEND KI | <table border="1"> <thead> <tr> <th>Code</th> <th>Description</th> <th>Qty</th> <th>UOM</th> </tr> </thead> <tbody> <tr> <td>RC1006A0</td> <td>D8 PET PIPE GUIDE BEND</td> <td>20.000</td> <td>PC</td> </tr> </tbody> </table> | Code | Description | Qty | UOM | RC1006A0 | D8 PET PIPE GUIDE BEND | 20.000 | PC | | | | | | | | |
| Code | Description | Qty | UOM | | | | | | | | | | | | | | | | | | |
| RC1006A0 | D8 PET PIPE GUIDE BEND | 20.000 | PC | | | | | | | | | | | | | | | | | | |



| COMPONENT | | | SPARE PART | | | | | | | | | | | | | | | | | | | | | | | | | | |
|-----------|---|---|------------|---|---|------|-------------|-----|-----|----------|---|--------|----|----------|-------------------------------------|-------|----|----------|--|-------|----|----------|---|-------|----|----------|--------------------------------------|-------|----|
| Code | Description | Image | Code | Description | Kit components | | | | | | | | | | | | | | | | | | | | | | | | |
| TB3283A | TB3283A0 |  | KTB1959A | Ø8 TB1815 TRANSPARENT PIPE 5M KIT | <table border="1"> <thead> <tr> <th>Code</th> <th>Description</th> <th>Qty</th> <th>UOM</th> </tr> </thead> <tbody> <tr> <td>TB1815A0</td> <td>7,93x4,75 PE TRANSP. PIPE (JG #PE08100N)</td> <td>5.000</td> <td>M</td> </tr> </tbody> </table> | Code | Description | Qty | UOM | TB1815A0 | 7,93x4,75 PE TRANSP. PIPE (JG #PE08100N) | 5.000 | M | | | | | | | | | | | | | | | | |
| Code | Description | Qty | UOM | | | | | | | | | | | | | | | | | | | | | | | | | | |
| TB1815A0 | 7,93x4,75 PE TRANSP. PIPE (JG #PE08100N) | 5.000 | M | | | | | | | | | | | | | | | | | | | | | | | | | | |
| TR1136A | 318°C -0/+24 1 POLE SAFETY THERMOSTAT |  | KTR1136A | 318°C -0/+24 SAFETY THERMOSTAT KIT | <table border="1"> <thead> <tr> <th>Code</th> <th>Description</th> <th>Qty</th> <th>UOM</th> </tr> </thead> <tbody> <tr> <td>0H8120A0</td> <td>XEVL BULB PASS-THROU GH COVER</td> <td>1.000</td> <td>PC</td> </tr> <tr> <td>GN1531A0</td> <td>THERMOSTAT BULB INLET SEALING</td> <td>1.000</td> <td>PC</td> </tr> <tr> <td>SL1045A0</td> <td>S57 BLACK SILICONE - 80ml CARTRIDGE</td> <td>1.000</td> <td>PC</td> </tr> <tr> <td>TR1136A0</td> <td>318°C -0/+24 1 POLE SAFETY THERMOSTAT</td> <td>1.000</td> <td>PC</td> </tr> <tr> <td>VI1220A1</td> <td>4,2x12 TCB SELF-TAPPIN G SCREW</td> <td>3.000</td> <td>PC</td> </tr> </tbody> </table> | Code | Description | Qty | UOM | 0H8120A0 | XEVL BULB PASS-THROU GH COVER | 1.000 | PC | GN1531A0 | THERMOSTAT BULB INLET SEALING | 1.000 | PC | SL1045A0 | S57 BLACK SILICONE - 80ml CARTRIDGE | 1.000 | PC | TR1136A0 | 318°C -0/+24 1 POLE SAFETY THERMOSTAT | 1.000 | PC | VI1220A1 | 4,2x12 TCB SELF-TAPPIN G SCREW | 3.000 | PC |
| Code | Description | Qty | UOM | | | | | | | | | | | | | | | | | | | | | | | | | | |
| 0H8120A0 | XEVL BULB PASS-THROU GH COVER | 1.000 | PC | | | | | | | | | | | | | | | | | | | | | | | | | | |
| GN1531A0 | THERMOSTAT BULB INLET SEALING | 1.000 | PC | | | | | | | | | | | | | | | | | | | | | | | | | | |
| SL1045A0 | S57 BLACK SILICONE - 80ml CARTRIDGE | 1.000 | PC | | | | | | | | | | | | | | | | | | | | | | | | | | |
| TR1136A0 | 318°C -0/+24 1 POLE SAFETY THERMOSTAT | 1.000 | PC | | | | | | | | | | | | | | | | | | | | | | | | | | |
| VI1220A1 | 4,2x12 TCB SELF-TAPPIN G SCREW | 3.000 | PC | | | | | | | | | | | | | | | | | | | | | | | | | | |
| VI1328A | VI1328A0 |  | VI1328A0 | VI1328A0 | | | | | | | | | | | | | | | | | | | | | | | | | |
| VM1188A | POWER BOARD WIRES PASS-THROUGH |  | KVM1188A | POWER BOARD WIRES PASS-THROUGH 10PCS KIT | <table border="1"> <thead> <tr> <th>Code</th> <th>Description</th> <th>Qty</th> <th>UOM</th> </tr> </thead> <tbody> <tr> <td>VM1188A0</td> <td>POWER BOARD WIRES PASS-THROU GH</td> <td>10.000</td> <td>PC</td> </tr> </tbody> </table> | Code | Description | Qty | UOM | VM1188A0 | POWER BOARD WIRES PASS-THROU GH | 10.000 | PC | | | | | | | | | | | | | | | | |
| Code | Description | Qty | UOM | | | | | | | | | | | | | | | | | | | | | | | | | | |
| VM1188A0 | POWER BOARD WIRES PASS-THROU GH | 10.000 | PC | | | | | | | | | | | | | | | | | | | | | | | | | | |



| COMPONENT | | | SPARE PART | | | | | | | | | | | | | | |
|--|--|--|------------|---|--|--|-------------|--|-------|----------|--|---|-------|----------|---|-------|----|
| Code | Description | Image | Code | Description | Kit components | | | | | | | | | | | | |
| VM2482A | ELECTR COMPONENTS HOLDER FRAME SHOP.PRO |  | KVM2482A | BAKERLUX SP ELECTR COMPONENTS HOLDER KIT | <table border="1"> <thead> <tr> <th>Code</th> <th>Description</th> <th>Qty</th> <th>UOM</th> </tr> </thead> <tbody> <tr> <td>VM2482A0</td> <td>ELECTR COMPONENT S HOLDER FRAME SHOP.PRO</td> <td>1.000</td> <td>PC</td> </tr> <tr> <td>VM2484A0</td> <td>ELECTRICAL CONNECTION CABLE CLAMP</td> <td>1.000</td> <td>PC</td> </tr> </tbody> </table> | Code | Description | Qty | UOM | VM2482A0 | ELECTR COMPONENT S HOLDER FRAME SHOP.PRO | 1.000 | PC | VM2484A0 | ELECTRICAL CONNECTION CABLE CLAMP | 1.000 | PC |
| | | | | | Code | Description | Qty | UOM | | | | | | | | | |
| VM2482A0 | ELECTR COMPONENT S HOLDER FRAME SHOP.PRO | 1.000 | PC | | | | | | | | | | | | | | |
| VM2484A0 | ELECTRICAL CONNECTION CABLE CLAMP | 1.000 | PC | | | | | | | | | | | | | | |
| <table border="1"> <thead> <tr> <th>Code</th> <th>Description</th> <th>Qty</th> <th>UOM</th> </tr> </thead> <tbody> <tr> <td>VM2483A1</td> <td>SHOP PRO COMPONENT S HOLDER COVER</td> <td>1.000</td> <td>PC</td> </tr> </tbody> </table> | Code | Description | Qty | UOM | VM2483A1 | SHOP PRO COMPONENT S HOLDER COVER | 1.000 | PC | | | | | | | | | |
| Code | Description | Qty | UOM | | | | | | | | | | | | | | |
| VM2483A1 | SHOP PRO COMPONENT S HOLDER COVER | 1.000 | PC | | | | | | | | | | | | | | |
| VM2483A | SHOP PRO COMPONENTS HOLDER COVER |  | KVM2483A | BL SHOP.PRO COMPONENTS HOLDER COVER KIT | <table border="1"> <thead> <tr> <th>Code</th> <th>Description</th> <th>Qty</th> <th>UOM</th> </tr> </thead> <tbody> <tr> <td>VM2483A1</td> <td>SHOP PRO COMPONENT S HOLDER COVER</td> <td>1.000</td> <td>PC</td> </tr> </tbody> </table> | Code | Description | Qty | UOM | VM2483A1 | SHOP PRO COMPONENT S HOLDER COVER | 1.000 | PC | | | | |
| Code | Description | Qty | UOM | | | | | | | | | | | | | | |
| VM2483A1 | SHOP PRO COMPONENT S HOLDER COVER | 1.000 | PC | | | | | | | | | | | | | | |
| VM2484A | ELECTRICAL CONNECTION CABLE CLAMP |  | KVM2484A | CABLE LOCKS ELECTRICAL CONNECTION KIT | <table border="1"> <thead> <tr> <th>Code</th> <th>Description</th> <th>Qty</th> <th>UOM</th> </tr> </thead> <tbody> <tr> <td>VM2484A0</td> <td>ELECTRICAL CONNECTION CABLE CLAMP</td> <td>1.000</td> <td>PC</td> </tr> </tbody> </table> | Code | Description | Qty | UOM | VM2484A0 | ELECTRICAL CONNECTION CABLE CLAMP | 1.000 | PC | | | | |
| | | | Code | Description | Qty | UOM | | | | | | | | | | | |
| | | | VM2484A0 | ELECTRICAL CONNECTION CABLE CLAMP | 1.000 | PC | | | | | | | | | | | |
| KVM2482A | BAKERLUX SP ELECTR COMPONENTS HOLDER KIT | <table border="1"> <thead> <tr> <th>Code</th> <th>Description</th> <th>Qty</th> <th>UOM</th> </tr> </thead> <tbody> <tr> <td>VM2482A0</td> <td>ELECTR COMPONENT S HOLDER FRAME SHOP.PRO</td> <td>1.000</td> <td>PC</td> </tr> <tr> <td>VM2484A0</td> <td>ELECTRICAL CONNECTION CABLE CLAMP</td> <td>1.000</td> <td>PC</td> </tr> </tbody> </table> | Code | Description | Qty | UOM | VM2482A0 | ELECTR COMPONENT S HOLDER FRAME SHOP.PRO | 1.000 | PC | VM2484A0 | ELECTRICAL CONNECTION CABLE CLAMP | 1.000 | PC | | | |
| Code | Description | Qty | UOM | | | | | | | | | | | | | | |
| VM2482A0 | ELECTR COMPONENT S HOLDER FRAME SHOP.PRO | 1.000 | PC | | | | | | | | | | | | | | |
| VM2484A0 | ELECTRICAL CONNECTION CABLE CLAMP | 1.000 | PC | | | | | | | | | | | | | | |
| | | | | | | | | | | | | | | | | | |